

# TM.PRIMO C

## DISCREET PROTECTION

- » extended lifetime thanks to LiFePO4 packages
- » minimalistic design
- » easy installation thanks to the modular electronics design
- » easy and quick installation
- » recessed installation

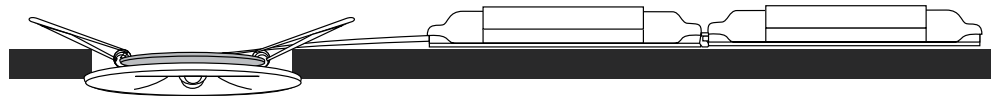
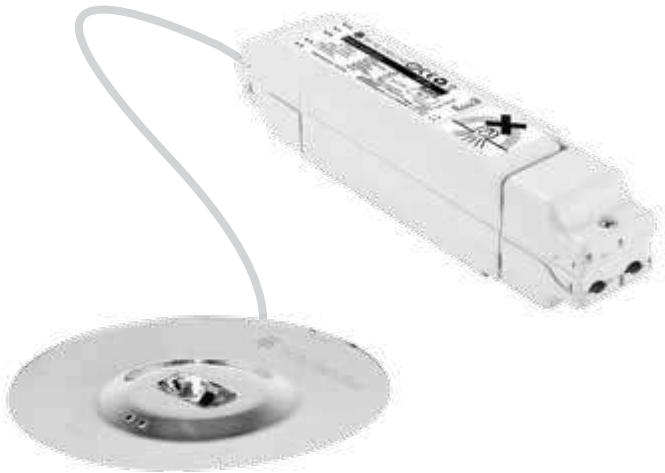

» recessed installation

104

Dimensions [ $\pm 2$  mm]

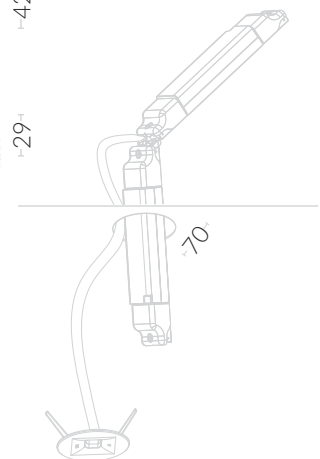
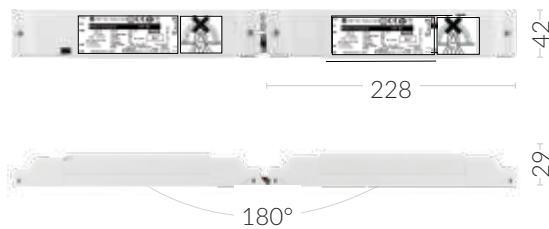

Application	anti-panic lighting escape route lighting
Light source	LED 
Testing for self-contained	non-addressable: ST – for button test non-addressable: AT – auto-test / self-test addressable: DATA – with addressable module for DATA system addressable: DATA 2 – with addressable module for DATA 2 system addressable: DALI – with addressable module for DALI systems
Testing for central battery	non-addressable: CB – without addressable module addressable : CBA – with addressable module
Power supply	210÷250 V AC 50÷60 Hz 186÷254 V DC
Protection degree	IP20
Insulation class	I
Temperature range	ST, AT, DATA, DATA 2, DALI: $t_a +10^{\circ}\text{C} \div +35^{\circ}\text{C}$ CB: $t_a -15^{\circ}\text{C} \div +55^{\circ}\text{C}$ CBA: $t_a -10^{\circ}\text{C} \div +40^{\circ}\text{C}$
Glow wire test	850°C
Colour	<input checked="" type="checkbox"/> - stainless steel <input type="checkbox"/> RAL 9003 <input checked="" type="checkbox"/> RAL 9005 - black steel
Material	housing: stainless steel (polished/brushed) or RAL 9003 / RAL 9005 powder coated black steel

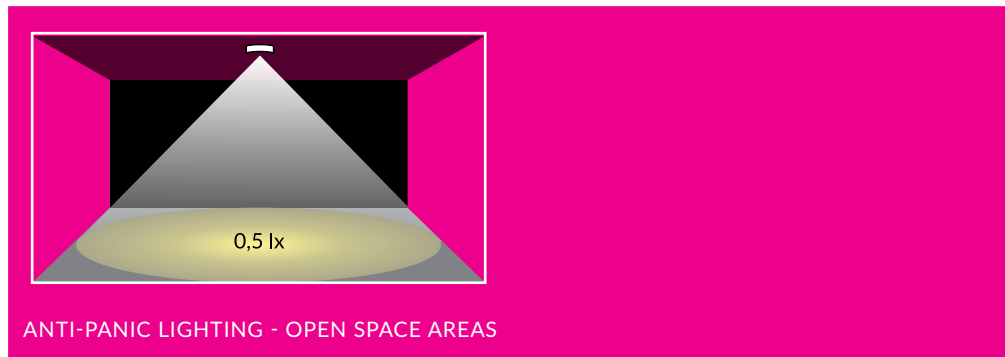

Model	Mode	Time	Battery	Testing
TM.PRIMO C M2	M / NM	1 / 3 h	LiFePO4	ST / AT / DATA / DATA 2 / DALI
TM.PRIMO C M2H	M / NM	1 / 3 h	LiFePO4	ST / AT / DATA / DATA 2 / DALI
TM.PRIMO C M2	-	-	-	CB, CBA
TM.PRIMO C M2H	-	-	-	CB, CBA

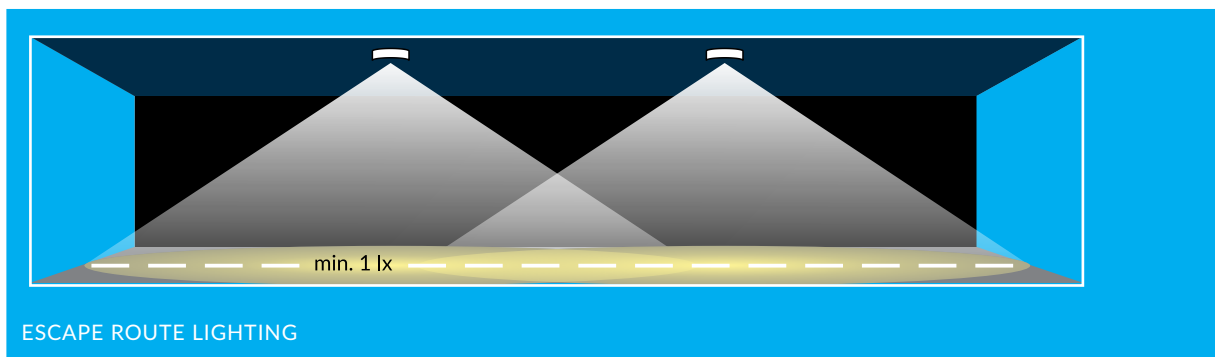

Model	Mode	Time	Battery	Testing
TM.PRIMO C C1	M / NM	1 / 3 h	LiFePO4	ST / AT / DATA / DALI
TM.PRIMO C C1H	M / NM	1 / 3 h	LiFePO4	ST / AT / DATA / DALI
TM.PRIMO C C1	-	-	-	CB, CBA
TM.PRIMO C C1H	-	-	-	CB, CBA