

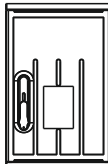
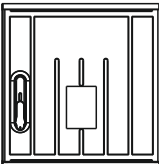
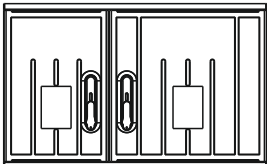
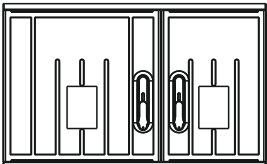
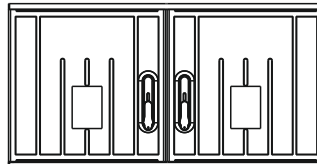
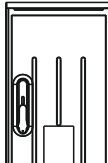
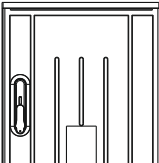
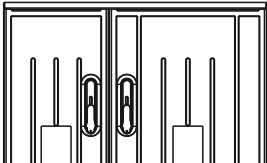
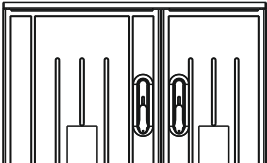
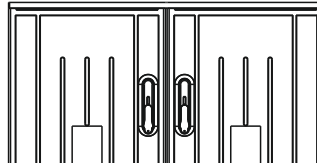
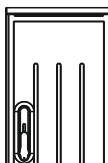
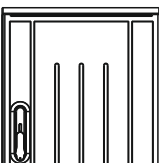
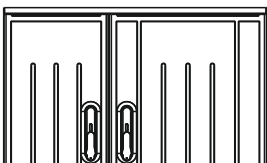
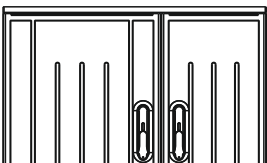
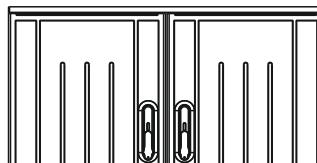
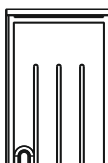
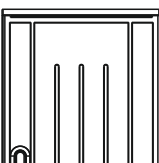
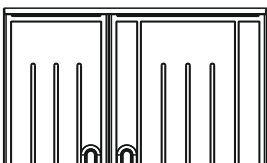
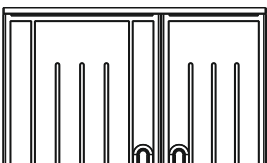
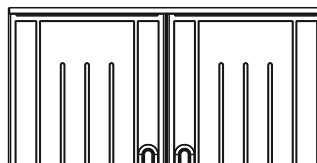

## OT Lábazati kültéri szekrények / Outdoor plinth cabinet

		szélesség / width				
		265 mm	400 mm	660 mm	660 mm	800 mm
magasság / height	400 mm	 OT 24	 OT 44	 OT 64.2/24	 OT 64.2/42	 OT 84.2/44
	500 mm	 OT 25	 OT 45	 OT 65.2/24	 OT 65.2/42	 OT 85.2/44
	600 mm	 OT 26	 OT 46	 OT 66.2/24	 OT 66.2/42	 OT 86.2/44
	800 mm	 OT 28	 OT 48	 OT 68.2/24	 OT 68.2/42	 OT 88.2/44

VILÁGÍTÁS-  
TECHNIKA

ENERGIA  
ELOSZTÓK

AUTOMATI-  
ZÁLÁS

ELEKTROMOS  
SZEKRENYEK

SZERELÉS-  
TECHNIKA

KÁBELEK,  
VEZETÉKEK

KAPCSOLÓ-  
CSALÁDOK

VILLÁM-  
VÉDELEM

SZELLŐZÉS  
TECHNIKA

TOVÁBBI  
TERMÉKEINK

### Lábazatok / foundations

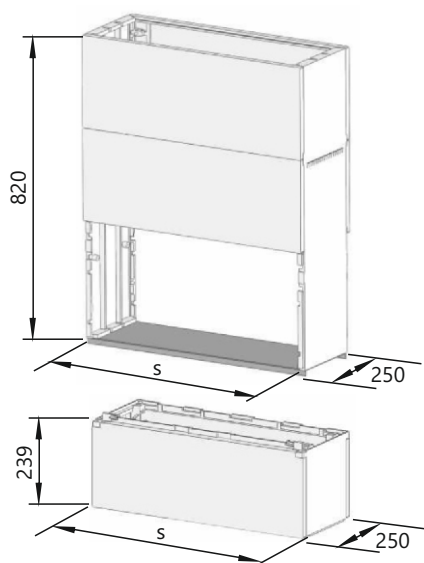

OT F	
Típus / Types	s (mm)
OT FS-2	260
OT FS-4	400
OT FS-5	530
OT FS-6	660
OT FS-8	800
OT FS-10	1060

OT FN	
Típus / Types	s (mm)
OT FSN-2	260
OT FSN-4	400
OT FSN-5	530
OT FSN-6	660
OT FSN-8	800
OT FSN-10	1060



# Elosztó-, fogyasztásmérő szekrények

OT Lábazati kültéri szekrények / Outdoor plinth cabinet

VILÁGÍTÁS-  
TECHNIKA

ENERGIA  
ELOSZTÓK

AUTOMATI-  
ZÁLÁS

ELEKTROMOS  
SZEKRÉNYEK

SZERELÉS-  
TECHNIKA

KÁBELEK,  
VEZETÉKEK

KAPCSOLÓ-  
CSALÁDOK

VILLÁM-  
VÉDELEM

SZELLŐZÉS  
TECHNIKA

TOVÁBBI  
TERMÉKEINK

szélesség / width

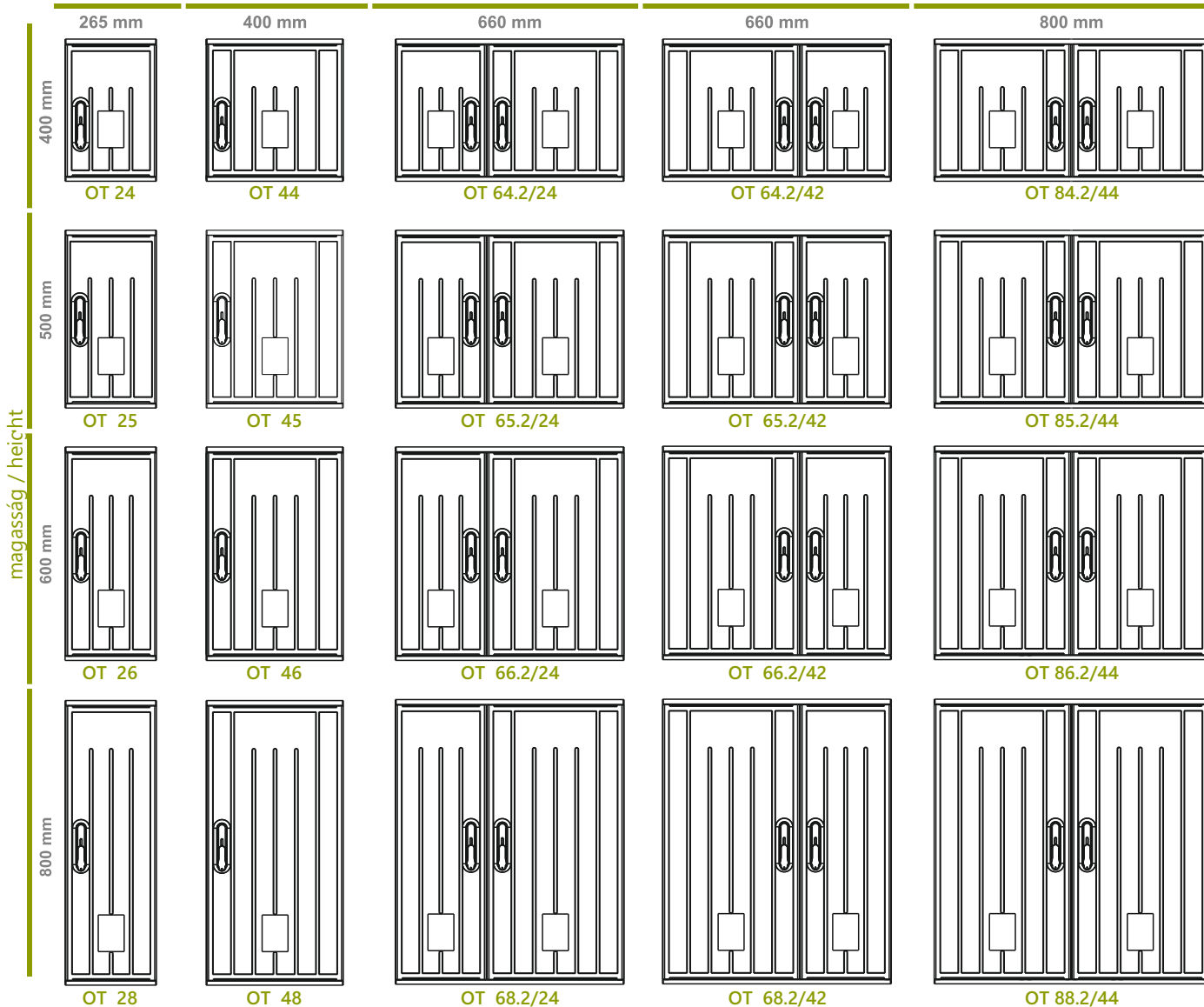

## Lábzatok / foundations

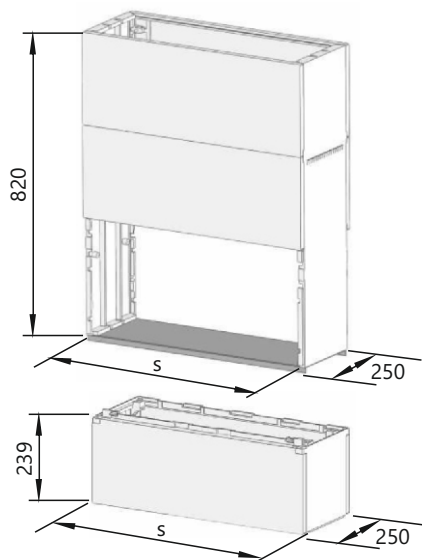

OT F	
Típus / Types	s (mm)
OT FS-2	260
OT FS-4	400
OT FS-5	530
OT FS-6	660
OT FS-8	800
OT FS-10	1060

OT FN	
Típus / Types	s (mm)
OT FSN-2	260
OT FSN-4	400
OT FSN-5	530
OT FSN-6	660
OT FSN-8	800
OT FSN-10	1060