

Contacte auxiliare și unități de semnalizare defect

Tip	Funcție
Contacte auxiliare:	Oferă informații despre starea contactelor principale a înteruptorului compact
Contacte de semnalizare defect:	Oferă informații despre declanșarea înteruptorului modular compact datorită unui scurtcircuit, suprasarcină sau operare.
Contacte de semnalizare defect/ auxiliare:	Cu ajutorul unității cu contacte creată prin combinarea celor două unități de mai sus se pot rezolva și sarcini combinate de comandă.

I_{th} 1 A	AC 15	I_e 0,8 A	 350 mm
------------------------------	-----------------	-------------------------------	---





MKM-AX



MKM-AL



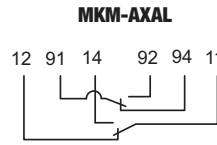
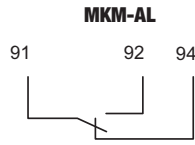
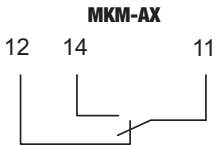

MKM-AXAL

TRACON	Denumire		
MKM-AX100	Contact auxiliar	MKM1-..	0,25 mm ²
MKM-AX250	Contact auxiliar	MKM2-..	0,35 mm ²
MKM-AL100	Contact de semnalizare defect	MKM1-..	0,25 mm ²
MKM-AL250	Contact de semnalizare defect	MKM2-..	0,35 mm ²
MKM-AXAL100	Contact semnalizare defect/contact auxiliar	MKM1-..	0,25 mm ²
MKM-AXAL250	Contact semnalizare defect/contact auxiliar	MKM2-..	0,35 mm ²



Declanșator tensiune de lucru

TRACON		
MKM-SHT1-230	MKM1-..	P ON  ON
MKM-SHT2-230	MKM2-..	<30 VA
		0,25 mm ²
		0,35 mm ²



U_m 230 V AC

 350 mm



Cu ajutorul lui înteruptorul modular compact se poate comanda de la distanță. SHT1-230 se poate instala în partea dreaptă și stângă a înteruptoarelor, pe când SHT2-230 se poate instala în partea dreaptă a înteruptoarelor. Unitatea declanșează deja înteruptorul de la 0,7 din tensiunea de acționare. Durata tensiunii de acționare este de max. 1 s.

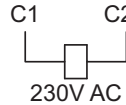

Găuri de fixare

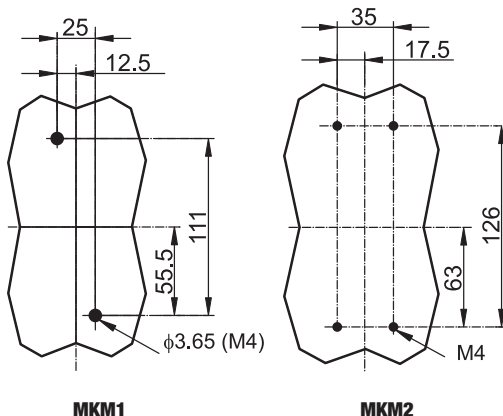

Pozițiile brațului de comutare

