

Technical details
Dimensions in mm

Dimensions of the interior installation depth with installed mounting plates.

The width of Mi Empty boxes Mi 9... enlarges about 15 mm because of the laterally mounted lid hinges, refer to product pages.

 = usable installation space with mounted cable glands

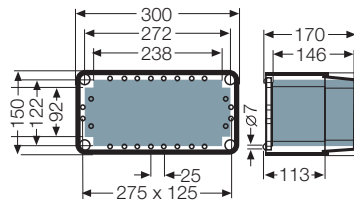

Mi 0100
Mi 0101
Mi 9100
Mi 9101

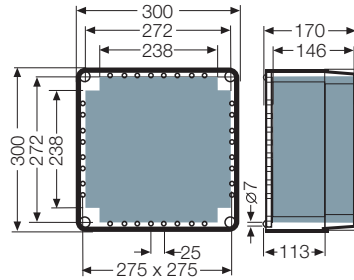

Mi 0200
Mi 0201
Mi 9200
Mi 9201

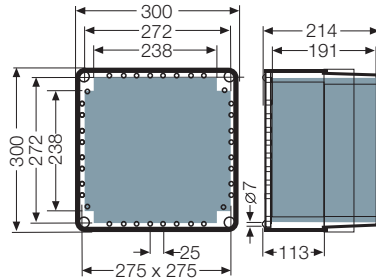

Mi 0210
Mi 0211
Mi 9210
Mi 9211

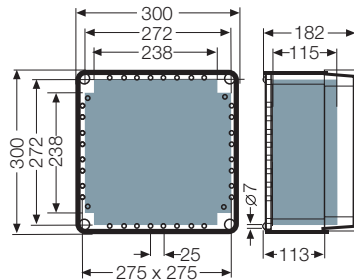

Mi 0220
Mi 0221

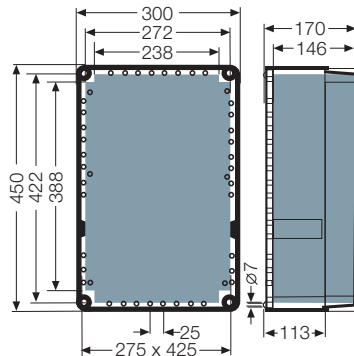

Mi 0300
Mi 0301
Mi 9310
Mi 9311

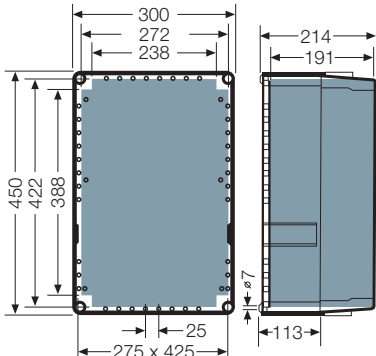

Mi 0310
Mi 0311
Mi 9310
Mi 9311

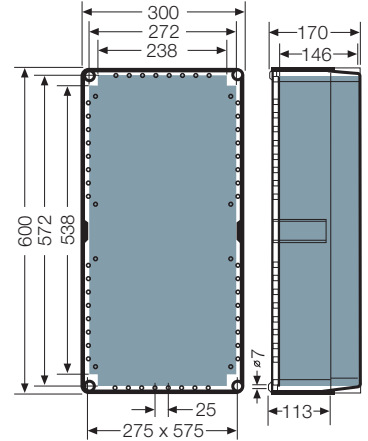

Mi 0400
Mi 0401
Mi 9400
Mi 9401

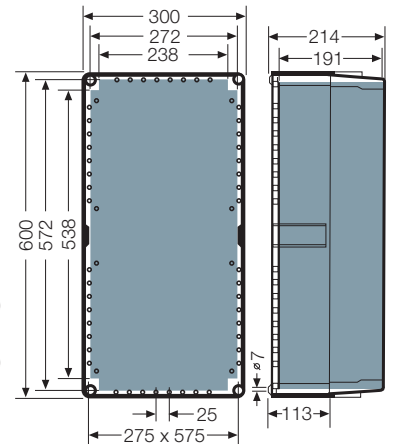

Mi 0410
Mi 0411
Mi 9410
Mi 9411

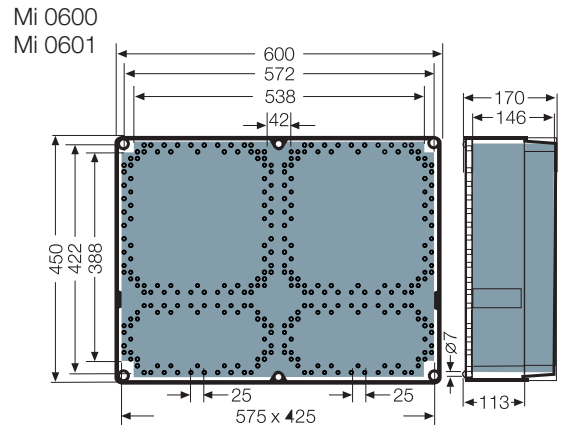

Mi 0600
Mi 0601

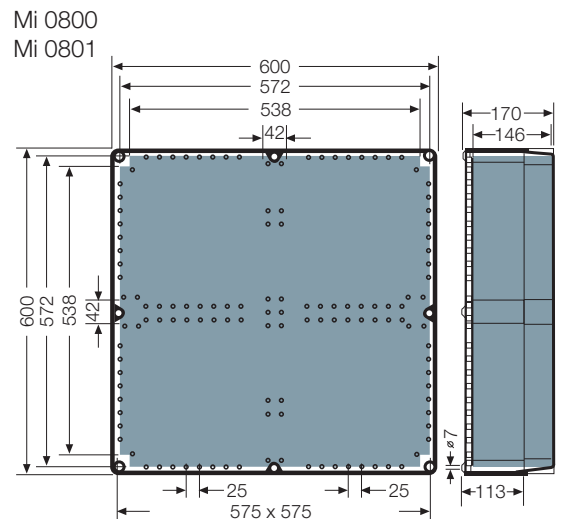

Mi 0800
Mi 0801

Installation of equipment in protection plates:

Pre-drill the sections at the corners, then saw away the section from the protection plate by using a piercing saw at middle to low cutting speed.

Use coarse toothed saw blades for plastics (e.g. Bosch T 101 B).

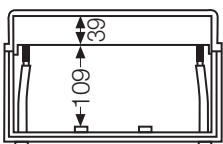

Empty enclosures
transparent or opaque lids

Empty enclosures
hinged transparent or opaque lids



Mi 0100
built-in dimensions
275x125x146 mm



Mi 0101
built-in dimensions
275x125x146 mm

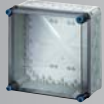

Mi 0200
built-in dimensions
275x275x146 mm



Mi 0201
built-in dimensions
275x275x146 mm



Mi 0210
built-in dimensions
275x275x191 mm



Mi 0211
built-in dimensions
275x275x191 mm



Mi 0220
built-in dimensions
275x275x115 mm
hinged lid



Mi 0221
built-in dimensions
275x275x115 mm
hinged lid



Mi 0300
built-in dimensions
275x425x146 mm



Mi 0301
built-in dimensions
275x425x146 mm



Mi 0310
built-in dimensions
275x425x191 mm



Mi 0311
built-in dimensions
275x425x191 mm



Mi 0400
built-in dimensions
275x575x146 mm



Mi 0401
built-in dimensions
275x575x146 mm



Mi 0410
built-in dimensions
275x575x191 mm



Mi 0411
built-in dimensions
275x575x191 mm



Mi 0600
built-in dimensions
575x425x146 mm



Mi 0601
built-in dimensions
575x425x146 mm



Mi 0800
built-in dimensions
575x575x146 mm



Mi 0801
built-in dimensions
575x575x146 mm



Mi 9100
built-in dimensions
122x272x146 mm,
hinged lid



Mi 9101
built-in dimensions
122x272x146 mm,
hinged lid



Mi 9200
built-in dimensions
275x275x146 mm,
hinged lid



Mi 9201
built-in dimensions
275x275x146 mm,
hinged lid



Mi 9210
built-in dimensions
275x275x191 mm,
hinged lid



Mi 9211
built-in dimensions
275x275x191 mm,
hinged lid



Mi 9300
built-in dimensions
275x425x146 mm,
hinged lid



Mi 9301
built-in dimensions
275x425x146 mm,
hinged lid



Mi 9310
built-in dimensions
275x425x191 mm,
hinged lid



Mi 9311
built-in dimensions
275x425x191 mm,
hinged lid



Mi 9400
built-in dimensions
275x575x146 mm,
hinged lid



Mi 9401
built-in dimensions
275x575x146 mm,
hinged lid

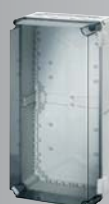

Mi 9410
built-in dimensions
275x575x191 mm,
hinged lid



Mi 9411
built-in dimensions
275x575x191 mm,
hinged lid

Empty boxes for the installation of different electrical devices either directly over attachments in the base of the enclosures or on DIN rails or mounting plates.

Empty boxes with hinged lids applicable as single empty box for the installation of device via DIN rails or mounting plates. The lid keeps permanently connected to the box. Built-in devices can be easily operated and for example measurements conveniently carried out with both hands.



Mi 0301

Built-in dimensions W 275 x H 425 x D 150 mm

- max. installation depth with built-in mounting plate 146 mm, with built-in DIN rail 135 mm
- box size 3
- please order DIN rails, mounting plates or covers additionally
- with opaque lid
- lid fasteners for tool operation

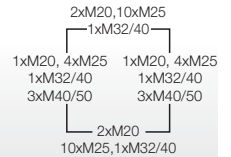
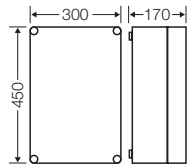

Mi 0311

Built-in dimensions W 275 x H 425 x D 195 mm

- max. installation depth with built-in mounting plate 191 mm, with built-in DIN rail 180 mm
- box size 3
- please order DIN rails, mounting plates or covers additionally
- with opaque lid
- lid fasteners for tool operation

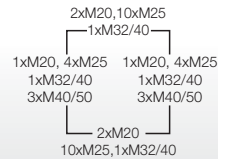
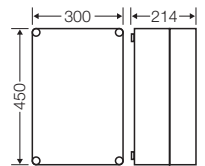

Mi 0401

Built-in dimensions W 275 x H 575 x D 150 mm

- max. installation depth with built-in mounting plate 146 mm, with built-in DIN rail 135 mm
- box size 4
- please order DIN rails, mounting plates or covers additionally
- with opaque lid
- lid fasteners for tool operation

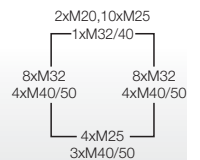
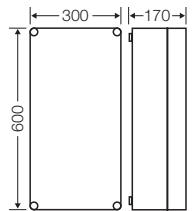

Please note:



Terminals for incoming/outgoing cables under accessories



Covers for protection of installation device, see accessories