

Transformatoare - seria T



LP601003T



LP603003T

Schrack-Info

Transformatoare compacte de calitate cu

- tensiuni în primar de 230 și 400Vca
- tensiuni în secundar de 12 - 230Vca

Modele la alegere, inclusiv siguranțe fuzibile în secundar

Funcție - transformatoare de siguranță

Transformatoare compacte pentru comenzi cu

- tensiuni în primar de 200 - 500Vca și
- tensiune în secundar de 230Vca

Funcție - transformatoare de siguranță

Dimensiuni LP60x

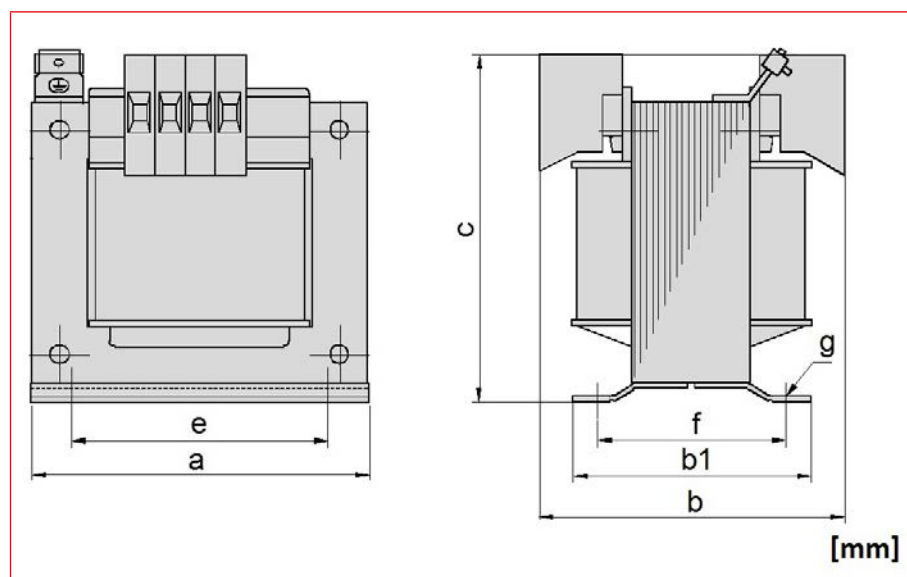

Tip	Putere nominală de ieșire [W]	Putere nominală pe termen scurt [W]	a [mm]	12V		24V		230V		e [mm]	f [mm]	g [mm]	b1 [mm]	Masă totală [kg]
				b [mm]	c [mm]	b [mm]	c [mm]	b [mm]	c [mm]					
LP60X003T	30	65	85	77	91	77	91	77	91	64	47	4,8x8	60	1,5
LP60X006T	60	130	85	77	91	77	91	77	91	64	47	4,8x8	60	1,5
LP60X010T	100	240	85	91	91	91	91	91	91	64	61	4,8x8	74	2
LP60X016T	160	360	85	100	91	100	91	100	91	64	70	4,8x8	83	2,3
LP60X020T	200	440	106	85	112	85	112	85	112	80	61	5,8x9	80	3
LP60X025T	250	600	106	94	112	94	112	94	112	80	70	5,8x9	89	3,8
LP60X032T	320	750	121	-	-	89	119	89	119	90	68	5,8x12	86	4,3
LP60X040T	400	1100	121	-	-	101	119	101	119	90	80	5,8x12	98	5,2
LP60X050T	500	1600	121	-	-	121	119	121	119	90	100	5,8x12	118	6,8
LP60X063T	630	1700	151	-	-	108	145	108	145	122	82	7x15	104	7,7
LP60X080T	800	2000	151	-	-	138	157	125	145	122	99	7x15	121	9,6
LP60X100T	1000	2800	151	-	-	164	157	151	145	122	125	7x15	147	13,4
LP60X130T	1300	3700	175	-	-	150	169	141	157	135	110	7x15	135	14,9
LP60X160T	1600	5500	195	-	-	142	240	142	174	150	110	10x18	140	17,4
LP60X200T	2000	7000	195	-	-	154	240	154	174	150	122	10x18	152	21,5
LP60X250T	2500	9000	195	-	-	154	240	154	174	150	122	10x18	152	21,5

X=1 (230/12VAC)

X=2 (230/24VAC)

X=3 (400/24VAC)

X=4 (400/230VAC)

X=5 (230/230VAC)

Transformatoare - seria T

Dimensiuni LP612

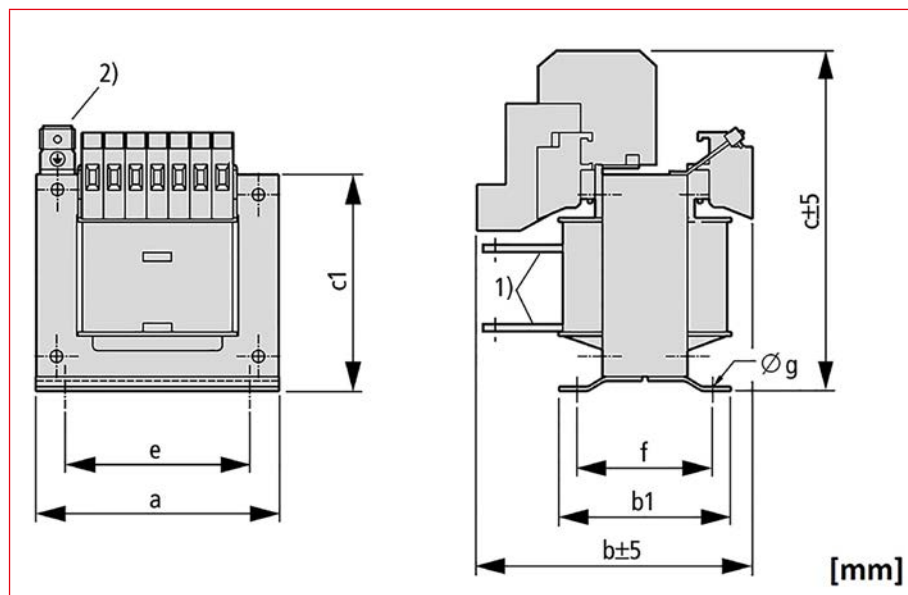

Tip	Putere nominală de ieșire [W]	Putere nominală pe termen scurt [W]	a [mm]	12V		24V		230V		e [mm]	f [mm]	g [mm]	b1 [mm]	c1 [mm]	Masă totală [kg]
				b [mm]	c [mm]	b [mm]	c [mm]	b [mm]	c [mm]						
LP612003T	30 VA	65 VA	121	-	-	88	119	88	119	90	69	5,8 x 12	86	106	4,3
LP612006T	60 VA	130 VA	85	75	91	91	75	75	91	64	47	4,8 x 8	60	76	1,5
LP612010T	100 VA	240 VA	85	89	91	89	91	89	91	64	61	4,8 x 8	74	76	2
LP612020T	200 VA	440 VA	106	83	112	83	112	83	112	80	61	5,8 x 12	80	97	3
LP612025T	250 VA	600 VA	106	111	124	91	112	91	112	80	70	5,8 x 12	89	97	3,8

Dimensiuni LP614

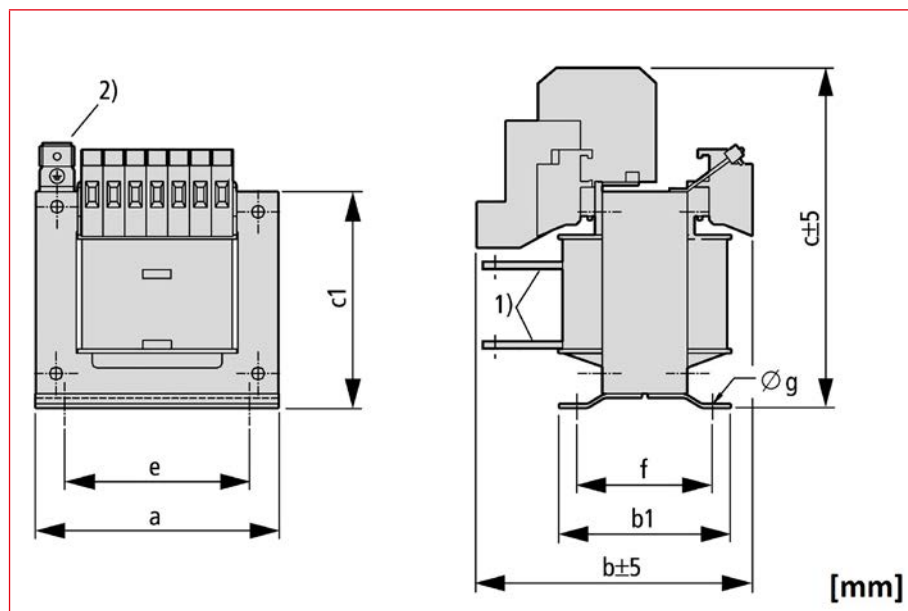

Tip	Putere nominală de ieșire [W]	Putere nominală pe termen scurt [W]	a [mm]	12V		24V		230V		e [mm]	f [mm]	g [mm]	b1 [mm]	c1 [mm]	Masă totală [kg]
				b [mm]	c [mm]	b [mm]	c [mm]	b [mm]	c [mm]						
LP614006T	60 VA	130 VA	85	75	91	91	75	75	91	64	47	4,8 x 8	60	76	1,5
LP614010T	100 VA	240 VA	85	89	91	89	91	89	91	64	61	4,8 x 8	74	76	2
LP614020T	200 VA	440 VA	106	83	112	83	112	83	112	80	61	5,8 x 12	80	97	3
LP614040T	400 VA	1100 VA	121	-	-	100	119	100	119	90	80	5,8 x 12	98	106	5,2

Transformatoare

Transformatoare - seria T

Dimensiuni LP691

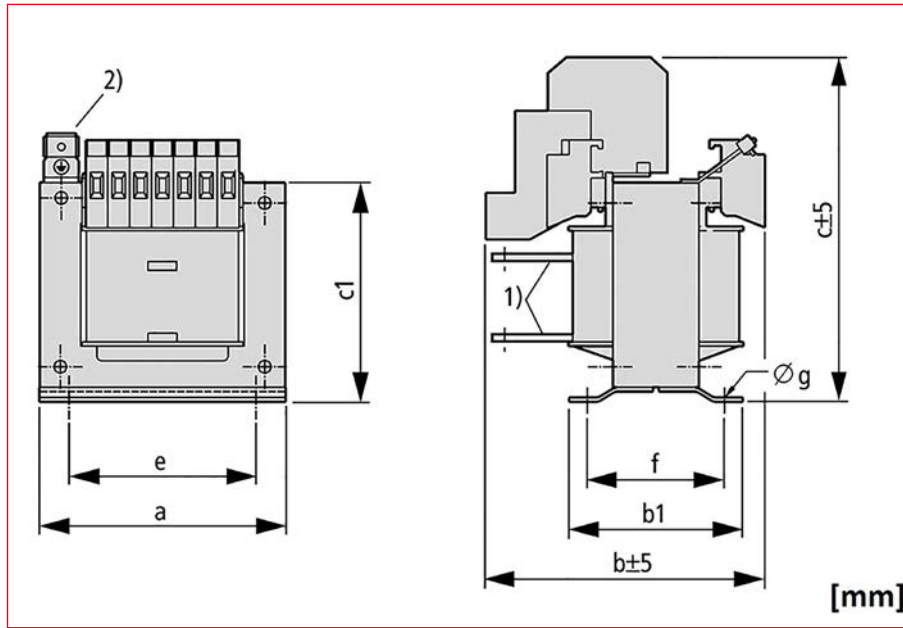

Tip	Putere nominală de ieșire [W]	Putere nominală pe termen scurt [W]	a [mm]	12V		24V		230V		e [mm]	f [mm]	g [mm]	b1 [mm]	c1 [mm]	Masă totală [kg]
				b [mm]	c [mm]	b [mm]	c [mm]	b [mm]	c [mm]						
LP691041T	315 VA	750 VA	121	-	-	88	119	88	119	80	68	5,8 x 12	86	106	4,3
LP691042T	500 VA	1600 VA	121	-	-	140	131	120	119	90	100	5,8 x 12	118	106	6,8
LP691043T	200 VA	440 VA	106	83	112	83	112	83	112	80	61	5,8 x 12	80	97	3



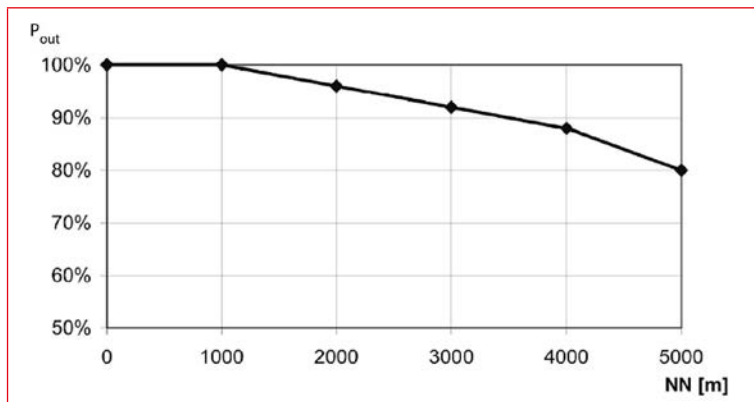



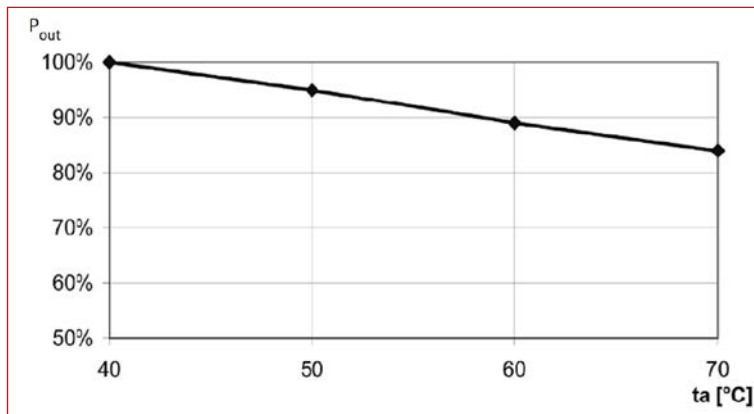







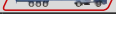

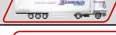





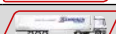













Zona de instalare

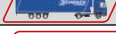

Temperatura ambiantă

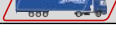

Transformatoare - seria T

DESCRIERE	STOC	STORE	COD COMANDĂ
Transformatoare de comandă monofazate 230/12Vca			
230V/12V, 30 VA, IP00			LP601003T
230V/12V, 60 VA, IP00			LP601006T
230V/12V, 100 VA, IP00			LP601010T
230V/12V, 160 VA, IP00			LP601016T
230V/12V, 315 VA, IP00			LP601032T
230V/12V, 500 VA, IP00			LP601050T
Transformatoare de comandă monofazate 230/24Vca			
230V/24V, 30 VA, IP00			LP602003T
230V/24V, 60 VA, IP00			LP602006T
230V/24V, 100 VA, IP00			LP602010T
230V/24V, 160 VA, IP00			LP602016T
230V/24V, 200 VA, IP00			LP602020T
230V/24V, 250 VA, IP00			LP602025T
230V/24V, 315 VA, IP00			LP602032T
230V/24V, 400 VA, IP00			LP602040T
230V/24V, 500 VA, IP00			LP602050T
230V/24V, 630 VA, IP00			LP602063T
230V/24V, 800 VA, IP00			LP602080T
230V/24V, 1000 VA, IP00			LP602100T
Transformatoare de comandă monofazate 230/24Vca inclusiv siguranțe fuzibile în secundar			
230V/24V, 30 VA, IP00, protecție sec. cu fuzibil			LP612003T
230V/24V, 60 VA, IP00, protecție sec. cu fuzibil			LP612006T
230V/24V, 100 VA, IP00, protecție sec. cu fuzibil			LP612010T
230V/24V, 200 VA, IP00, protecție sec. cu fuzibil			LP612020T
230V/24V, 250 VA, IP00, protecție sec. cu fuzibil			LP612025T
Transformatoare de comandă monofazate 400/24Vca			
400V/24V, 35 VA, IP00			LP603003T
400V/24V, 100 VA, IP00			LP603010T
400V/24V, 160 VA, IP00			LP603016T
400V/24V, 200 VA, IP00			LP603020T
400V/24V, 250 VA, IP00			LP603025T
400V/24V, 400 VA, IP00			LP603040T
400V/24V, 500 VA, IP00			LP603050T
400V/24V, 1000 VA, IP00			LP603100T
Transformatoare de comandă și separație, monofazate 230/230Vca			
230V/230V, 100 VA, IP00			LP605010T
230V/230V, 250 VA, IP00			LP605025T
230V/230V, 500 VA, IP00			LP605050T
230V/230V, 800 VA, IP00			LP605080T
230V/230V, 1000 VA, IP00			LP605100T
230V/230V, 1300 VA, IP00			LP605130T
230V/230V, 2000 VA, IP00			LP605200T
230V/230V, 2500 VA, IP00			LP605250T
Transformatoare de comandă monofazate 400/230Vca inclusiv siguranțe fuzibile în secundar			
400V/230V, 60 VA, IP00, protecție sec. cu fuzibil			LP614006T
400V/230V, 100 VA, IP00, protecție sec. cu fuzibil			LP614010T
400V/230V, 200 VA, IP00, protecție sec. cu fuzibil			LP614020T
400V/230V, 400 VA, IP00, protecție sec. cu fuzibil			LP614040T