



## configurator de întrerupătoare și prize configurator of switches and sockets

Modul Manager vă permite să efectuați un inventar complet și rapid al necesarului de prize și întrerupătoare din casa dumneavoastră sau chiar din șantier. Am elaborat o metodă unică de comandă, practică și rapidă în același timp. Puteți selecta culorile întrerupătoarelor, precum și forma ramelor, și astfel le puteți adapta la spațiul propriu sau la solicitările clienților. Încercați-ne! Aveți nevoie doar de un smartphone, o tabletă, sau un calculator și <http://modulmanager.tem.si>.

The Modul Manager allows you to perform a complete and quick inventory of switches from the building site itself or from the comfort of your own home. We have prepared a unique ordering method, which is both practical and quick. You can select the colours of the switches, as well as the shape of the frames, meaning you can tailor them to your space or the client's demands. Why not try us out? All you need is a smartphone, a tablet, or a computer and <http://modulmanager.tem.si>.

PRIZĂ KS CAT6 SCH RJ45 8/8 1M

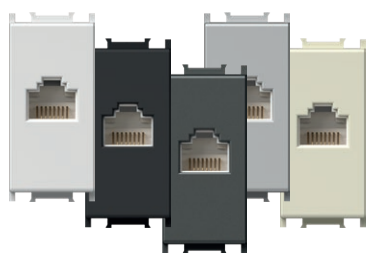

- KM39PW
- KM39SB
- KM39AT
- KM39ES
- KM39IW

- standard fixare KS keystone
- CAT6 UTP toolless, RJ45 8/8
- în conformitate cu ISO/IEC 11801

*SOCKET CAT6 SCH KS RJ45 8/8 1M*

- KS keystone fixing standard
- CAT6 UTP toolless, RJ45 8/8
- in accordance with ISO/IEC 11801



ADAPTOR KS UNIVERSAL 1M

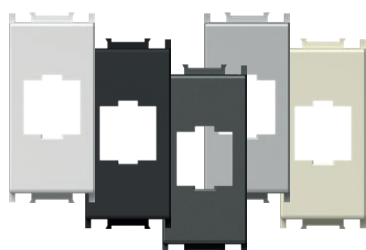

- KM50PW
- KM50SB
- KM50AT
- KM50ES
- KM50IW

- standard fixare KS keystone
- adecvat pentru HDMI, USB
- modulul de comunicații nu este inclus

*ADAPTER KS UNIVERSAL 1M*

- KS keystone fixing standard
- suitable for HDMI, USB
- communication module not included



ADAPTOR PD 1M

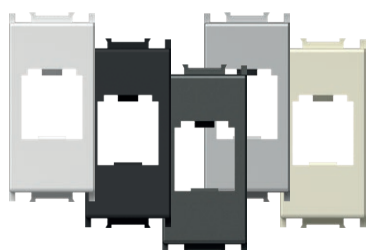

- KM40PW
- KM40SB
- KM40AT
- KM40ES
- KM40IW

- standard de fixare PD Panduit Mini-COM
- modulul de comunicații nu este inclus

*ADAPTER PD 1M*

- PD Panduit Mini-COM fixing standard
- communication module not included



ADAPTOR PD CU PROTECȚIE LA PRAF 1M



- KM43PW
- KM43SB
- KM43AT
- KM43ES
- KM43IW

- standard fixare PD Panduit Mini-COM cu protecție praf
- modulul de comunicații nu este inclus

*ADAPTER PD WITH DUST PROTECTION 1M*

- PD Panduit Mini-COM fixing standard with dust protection
- communication module not included



ADAPTOR R&M 1M

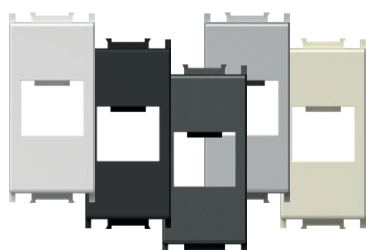

- KM46PW
- KM46SB
- KM46AT
- KM46ES
- KM46IW

- standard fixare R&M
- modulul de comunicații nu este inclus

*ADAPTER R&M 1M*

- R&M fixing standard
- communication module not included



ADAPTOR R&M CAT6A 1M

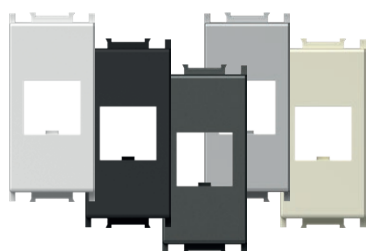

- KM52PW
- KM52SB
- KM52AT
- KM52ES
- KM52IW

- sistem de fixare R&M pentru CAT6A
- modulul de comunicare nu este inclus

*ADAPTER R&M CAT6A 1M*

- R&M fixing for CAT6A
- communication module not included



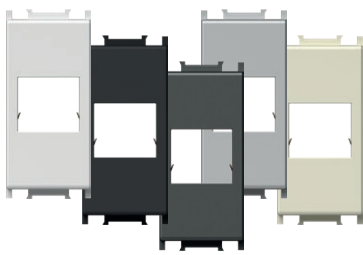

- KM45PW
- KM45SB
- KM45AT
- KM45ES
- KM45IW

**ADAPTOR LK 1M**

- standard de fixare LK LeoniKerpen eLine / BKS NewLine
- modulul de comunicații nu este inclus

*ADAPTER LK 1M*

- LK LeoniKerpen eLine / BKS NewLine fixing standard
- communication module not included

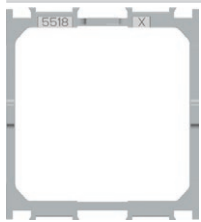

KA26

**ADAPTOR NEXANS/SCHRACK 2M**

- adaptor de fixare pentru modulele Nexans LANmark și Schrack 45x45mm
- adecvat pentru Nexans tip N423.540N
- adecvat pentru Schrack tip HSEMD02W2F
- modulul de comunicații nu este inclus

*ADAPTER NEXANS/SCHRACK 2M*

- fixing adapter for Nexans LANmark and Schrack module 45x45mm
- suitable for Nexans type N423.540N
- suitable for Schrack type HSEMD02W2F
- communication module not included

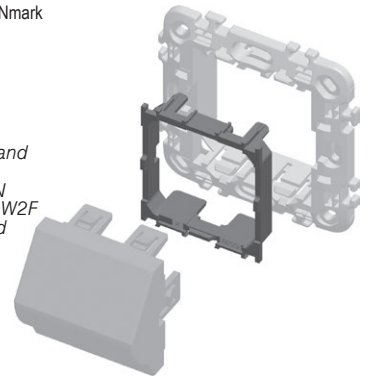

- KM48PW
- KM48SB
- KM48AT
- KM48ES
- KM48IW

**ADAPTOR AT&T SYSTEMAX CU PROTECȚIE LA PRAF 1M**

- standard de fixare AT&T Systemax cu protecție împotriva prafului
- modulul de comunicații nu este inclus

*ADAPTER AT&T SYSTEMAX WITH DUST PROTECTION 1M*

- AT&T Systemax fixing standard with dust protection
- communication module not included



- KM51PW
- KM51SB
- KM51AT
- KM51ES
- KM51IW

**PRIZĂ USB TIP A 1M**

- priză USB 2.0 tip A
- cleme cu șurub, raster 5 mm, 1,5 mm<sup>2</sup>, 1x2P + 1x3P
- cablare:
  - PIN 1 – VCC (+5V, conductor roșu)
  - PIN 2 – Date - (conductor alb)
  - PIN 3 – Date + (conductor verde)
  - PIN 4 – GND - împământare (conductor negru)
  - S – ecranare
- în conformitate cu directiva 2011/95/UE (RoHS2)

*SOCKET USB TYPE A 1M*

- USB 2.0 socket type A
- screw contacts, raster 5 mm, 1,5 mm<sup>2</sup>, 1x2P + 1x3P
- wiring:
  - PIN 1 – VCC (+5V, red wire)
  - PIN 2 – Data - (white wire)
  - PIN 3 – Data + (green wire)
  - PIN 4 – GND - ground (black wire)
  - S – shield
- in accordance with directive 2011/95/EU (RoHS2)



1M = 22,5 x 45  
2M = 45 x 45

