

## Descărcătoare de supratensiune (clasa T2) - seria Vartec



IS111311



IS111341



IS111330



IS010340



IS010352



IS010350

### Schrack-Info

Seria Schrack Vartec cuprinde numai descărcătoare de supratensiune (T2). Această serie a fost verificată și certificată conform IEC/EN 61643.

Utilizarea descărcătoarelor SCHRACK Vartec este necesară în toate instalațiile electrice nou construite sau existente.

La montarea independentă de zonă, în interiorul unei încăperi, se vor respecta standardele naționale de aplicare (În Austria: ÖVE/ÖNORM E 8001).

Aceste descărcătoare sunt executate în variante modulare și debrășabile, astfel că modulul poate fi înlocuit foarte ușor în cazul suprasolicitării acestuia.

### Desen dimensional

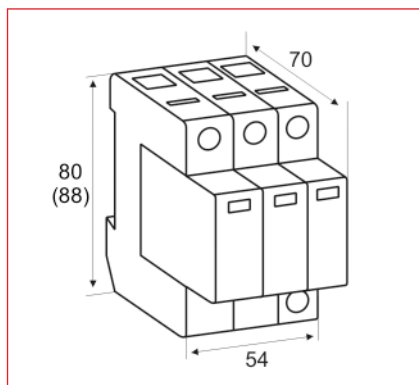

### Desen dimensional

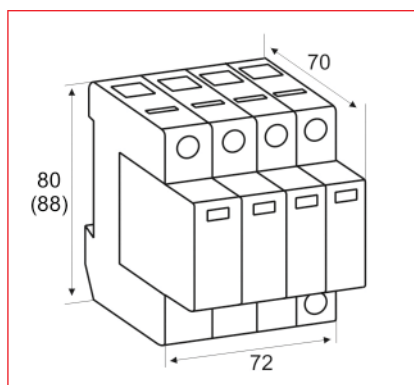





## Descărcătoare de supratensiune (clasa T2) - seria Vartec







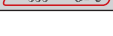



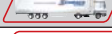

	Tensiune de ținere permanentă		Module cu clasă de test 2 / 20 kA (8/20)		Module cu clasă de test 2 / 15 kA (8/20)		Seturi	
			Cu contact auxiliar	Fără contact auxiliar	Cu contact auxiliar	Fără contact auxiliar	Cu contact auxiliar	Fără contact auxiliar
230 V (2+0)	255 V AC	Socluri	ISO10323	ISO10322	ISO10323	ISO10322		
		Module insert	2 x ISO10352	2 x ISO10352	2 x ISO10351	2 x ISO10351		
	335 V AC	Socluri	ISO10323	ISO10322	ISO10323	ISO10322		
		Module insert	2 x ISO10354	2 x ISO10354	2 x ISO10353	2 x ISO10353		
230 V (1+1)	255 V AC	Socluri	ISO10321	ISO10320	ISO10321	ISO10320	x	x
		Module insert	ISO10352 + ISO10350	ISO10352 + ISO10350	ISO10351 + ISO10350	ISO10351 + ISO10350		
	335 V AC	Socluri	ISO10321	ISO10320	ISO10321	ISO10320		
		Module insert	ISO10354 + ISO10350	ISO10354 + ISO10350	ISO10353 + ISO10350	ISO10353 + ISO10350		
TN-C (3+0)	255 V AC	Socluri	ISO10331	ISO10330	ISO10331	ISO10330	IS111331	IS111330
		Module insert	3 x ISO10352	3 x ISO10352	3 x ISO10351	3 x ISO10351		
	335 V AC	Socluri	ISO10331	ISO10330	ISO10331	ISO10330		
		Module insert	3 x ISO10354	3 x ISO10354	3 x ISO10353	3 x ISO10353		
TN-S (4+0)	255 V AC	Socluri	ISO10343	ISO10342	ISO10343	ISO10342	IS111341	IS111340
		Module insert	4 x ISO10352	4 x ISO10352	4 x ISO10351	4 x ISO10351		
	335 V AC	Socluri	ISO10343	ISO10342	ISO10343	ISO10342		
		Module insert	4 x ISO10354	4 x ISO10354	4 x ISO10353	4 x ISO10353		
TT [TN-S] (3+1)	255 V AC	Socluri	ISO10341	ISO10340	ISO10341	ISO10340	IS111311	IS111310
		Module insert	3 x ISO10352 + ISO10350	3 x ISO10352 + ISO10350	3 x ISO10351 + ISO10350	3 x ISO10351 + ISO10350		
	335 V AC	Socluri	ISO10341	ISO10340	ISO10341	ISO10340		
		Module insert	3 x ISO10354 + ISO10350	3 x ISO10354 + ISO10350	3 x ISO10353 + ISO10350	3 x ISO10353 + ISO10350		
Clasă de protecție la supratensiune			Module cu clasă de test 2 / 20 kA (8/20)		Module cu clasă de test 2 / 15 kA (8/20)		Seturi T2 / C / II	
Curent de descărcare nominal $I_n$ (8/20)			20 kA		15 kA		20 kA	
Curent de descărcare maxim $I_{max}$ (8/20)			40 kA		30 kA		40 kA	
Tensiune de ținere permanentă $U_c$			255 / 335 V AC				255 V AC	
Curent rezidual $I_r$			-----					
Nivel de protecție $U_p$ (la $I_n$ )			$\leq 1.5$ kV					
Tensiune reziduală la 5 kA:			$\leq 1.1$ kV					
Siguranță fuzibilă în amonte maximă			125 A gL					
Stabilitate la curent de scurtcircuit dinamic			25 kA / 50 Hz					
Material carcasă			Termoplastic, UL94V-0					
Domeniu de temperatură			-40°C - +80°C					

DESCRIERE STOC STORE COD COMANDĂ

### Module descărcător (patron inserabil) - seria Vartec

Modul VVM TII, 255V/20kA		<b>ISO10352</b>
Modul VGM TII, 20kA		<b>ISO10350</b>
Modul VVM TII, 255V/15kA		<b>ISO10351</b>
Modul VVM TII, 320V/15kA		<b>ISO10353</b>
Modul VVM TII, 320V/20kA		<b>ISO10354</b>

### Socluri - Seria Vartec

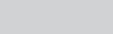
Soclu 1 pol pentru modul VVM		<b>ISO10310</b>
Soclu 1 pol+contact aux. pentru modul VVM		<b>ISO10311</b>
Soclu 1 pol pentru modul VGM		<b>ISO10312</b>
Soclu TII, 1+1, fără contact aux.		<b>ISO10320</b>
Soclu TII, 1+1, cu contact aux.		<b>ISO10321</b>
Soclu TII, 2+0, fără contact aux.		<b>ISO10322</b>
Soclu TII, 2+0, cu contact aux.		<b>ISO10323</b>
Soclu TII, 3+0, fără contact aux.		<b>ISO10330</b>
Soclu TII, 3+0, cu contact aux.		<b>ISO10331</b>
Soclu TII, 3+1, fără contact aux.		<b>ISO10340</b>
Soclu TII, 3+1, cu contact aux.		<b>ISO10341</b>
Soclu TII, 4+0, fără contact aux.		<b>ISO10342</b>
Soclu TII, 4+0, cu contact aux.		<b>ISO10343</b>

### Accesorii - seria Vartec

Baretă furcă 3p, pt. punte descărcător-diferențial	ISO10179
--	----------