

Wall inlets

230V
50-60Hz
3p = 6h

400V
50-60Hz
4p, 5p = 6h

500V
50-60Hz
4p, 5p = 7h



Current	Voltage	Poles	Degree of protection	Hour angle	Type	Packing pcs	Weight g/pc	Dimensions page/pic.
---------	---------	-------	----------------------	------------	------	-------------	-------------	----------------------



IPN 1632

16 A	230 V	3	IP 44	6 h	IPN 1632	9	156	25/40
16 A	400 V	4	IP 44	6 h	IPN 1643	9	170	25/40
16 A	500 V	4	IP 44	7 h	IP 1645	12	167	25/41
16 A	400 V	5	IP 44	6 h	IPN 1653	9	184	25/40



IPN 3253

32 A	230 V	3	IP 44	6 h	IPN 3232	6	202	25/40
32 A	400 V	4	IP 44	6 h	IPN 3243	6	249	25/40
32 A	500 V	4	IP 44	7 h	IP 3245	12	244	25/41
32 A	400 V	5	IP 44	6 h	IPN 3253	6	274	25/40



IPB 3253

16 A	400 V	5	IP 44	6 h	IPB 1653	9	182	25/40
32 A	400 V	5	IP 44	6 h	IPB 3253	6	282	25/40



IPNO 1653

16 A	400 V	5	IP 44	6 h	IPNO 1653	9	201	25/42
32 A	400 V	5	IP 44	6 h	IPNO 3253	6	291	25 /42

Reversing wall plug allows change phases by turning the rotary part.



IPG 1632

16 A	230 V	3	IP 67	6 h	IPG 1632	10	154	25/43
16 A	400 V	4	IP 67	6 h	IPG 1643	10	185	25/43
16 A	400 V	5	IP 67	6 h	IPG 1653	6	216	25/43



IPG 3253

32 A	230 V	3	IP 67	6 h	IPG 3232	12	271	25/43
32 A	400 V	4	IP 67	6 h	IPG 3243	12	274	25/43
32 A	400 V	5	IP 67	6 h	IPG 3253	3	307	25/43

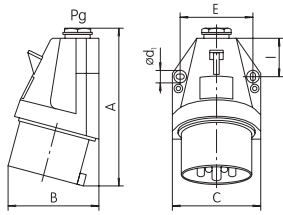
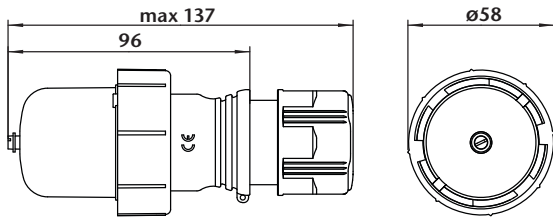

Type / mm	A	B	C	ød1	E	I	Gland
IP 1645	126	90,5	75	5,2	60	29,5	Pg 16
IP 3245	147	105	82	5,2	67	34	Pg 21

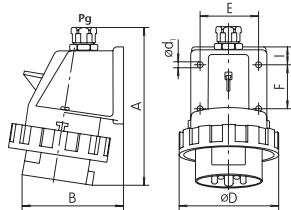

Type / mm	A	B	ød1	øD	E	F	I	Gland
IPG 1632	140	74	4,8	70	45	30	15	Pg 16
IPG 1643	143	83	5,2	78	50	30	17,5	Pg 16
IPG 1653	143	85	5,2	87	50	30	17,8	Pg 16
IPG 3232	172	95	5,2	92,5	58	40	20	Pg 21
IPG 3243	172	98	5,2	92,5	58	40	20	Pg 21
IPG 3253	172	101	5,2	100	58	40	20	Pg 21

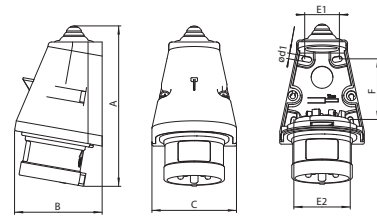
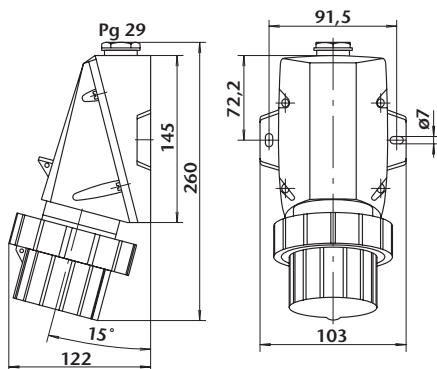

Type / mm	A	B	C	ød1	E1	E2	F
IPN 1632	147	81	78	5	30	53	58
IPN 1643	146	81	78	5	30	53	58
IPN, IPB 1653	146	81	78	5	30	53	58
IPN 3232	168	95	88	5	35	61	60
IPN 3243	168	95	88	5	35	61	60
IPN 3253	169	94	89	5	40	62	63
IPB 3253	169	94	89	5	40	62	63

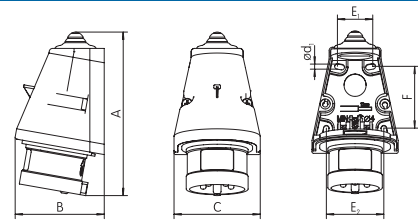

Type / mm	A	B	C	ød1	E1	E2	F
IPNO 1653	146	81	78	5	30	53	58
IPNO 3253	169	94	89	5	40	62	63

Note: Pin position can be changed by turning the screwdriver in 180 degrees and achieved the phase change.

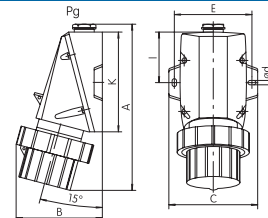

Type / mm	A	B	C	ød1	E	I	K	Gland
CPG 1632	170	83	86	4,8	74	50,7	101,4	Pg 16
CPG 3232	204	102	93,5	5,8	81	60,5	121	Pg 21

