

## LUX INTERNATIONAL PLATES

### TECHNOPOLYMER



GW 16 222 TB

#### LUX INTERNATIONAL - MILK WHITE

Code	Description	Type	Centre distance	Pack Carton
GW 16 222 TB	2 gang			12
GW 16 223 TB	2+2 gang	Horizontal	71 mm	6
GW 16 224 TB	2+2 gang	Vertical	71 mm	6
GW 16 225 TB	2+2 gang	Vertical	57 mm	6
GW 16 226 TB	2+2+2 gang	Horizontal	71 mm	1
GW 16 227 TB	2+2+2 gang	Vertical	71 mm	1
GW 16 228 TB	2+2+2+2 gang	Horizontal	71 mm	1
GW 16 229 TB	2+2+2+2 gang	Vertical	71 mm	1

**CHARACTERISTICS:** glossy finish. GW16225TB to be used with the GW24282PM box; for the installation use nr. 2 supports GW16822 vertically coupled by breaking the wings located on the contact side on both supports.



GW 16 222 YB

#### LUX INTERNATIONAL - MONOCHROME MILK WHITE

Code	Description	Type	Centre distance	Pack Carton
GW 16 222 YB	2 gang			12
GW 16 223 YB	2+2 gang	Horizontal	71 mm	6
GW 16 224 YB	2+2 gang	Vertical	71 mm	6
GW 16 226 YB	2+2+2 gang	Horizontal	71 mm	1
GW 16 227 YB	2+2+2 gang	Vertical	71 mm	1
GW 16 228 YB	2+2+2+2 gang	Horizontal	71 mm	1
GW 16 229 YB	2+2+2+2 gang	Vertical	71 mm	1

**CHARACTERISTICS:** glossy finish.

**NOTES:** under-plate and inner frame in the same white shade as the plate.



GW 16 222 TN

#### LUX INTERNATIONAL - TONER BLACK

Code	Description	Type	Centre distance	Pack Carton
GW 16 222 TN	2 gang			12
GW 16 223 TN	2+2 gang	Horizontal	71 mm	6
GW 16 224 TN	2+2 gang	Vertical	71 mm	6
GW 16 226 TN	2+2+2 gang	Horizontal	71 mm	1
GW 16 227 TN	2+2+2 gang	Vertical	71 mm	1
GW 16 228 TN	2+2+2+2 gang	Horizontal	71 mm	1
GW 16 229 TN	2+2+2+2 gang	Vertical	71 mm	1

**CHARACTERISTICS:** glossy finish.

# Chorus

## THE SHAPES OF BEAUTY



ONE, GEO, LUX, ART, ICE and ICE Touch are the plates for the Gewiss CHORUS innovative domestic range: six different forms reflecting the character, personality and style of those who live in the home. With full spontaneity of gestures and the simplicity of the commands.

## ALL THE BENEFITS OF A SINGLE FRAME

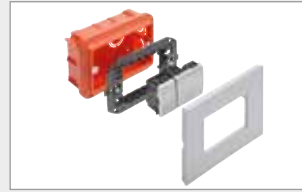

One single support (rectangular and square) compatible with all the plates of the Chorus range, without any need for additional adapters. The front coupling on the devices means quick, easy assembly and release without needing to remove the frame.

## ERGONOMICS AND DESIGN



The wide range of component customisation possibilities, in terms of colour and modularity, guarantees a wealth of design and ergonomic solutions for every context. Four different colours, three different finishes: glossy white and ivory, satin black and painted titanium guarantee the perfect combination of component and plate.

DOMESTIC RANGES

## General characteristics

TECHNICAL DATA AND REFERENCE STANDARDS							
Component	Reference standards	Essential electrical data*			Prolonged operation (no. of position changes)	Resistance to abnormal heat and fire	
		Resistance at test voltage (V)	Insulation resistance (MΩ)	Breaking capacity or category of use		Thermo-pressure with ball (°C)	Glow Wire Test (°C)
Commands	EN 60669-1	2000 at 50 Hz for 1 minute	> 5	1.25 In (200 position changes)	40,000 at In 250V- cosφ = 0.6	125	850
Italian Std. socket-outlets	IEC 60884-1			1.25 In (100 position changes)	10,000 at In 250V- cosφ = 0.8		
International Std. socket-outlets	IEC 60884-1			1.25 In (100 position changes)	10,000 at In 250V- cosφ = 0.8		
Latching relays	EN 60669-1 / EN 60669-2-2			40,000 at In 250V- cosφ = 0.6			
Momentary relays	EN 60669-1 / EN 60669-2-2			1.25 In (200 position changes)	4,000		
Miniature circuit breakers	EN 60898-1			3KA	8,000		
Residual current circuit breakers	EN 61009-1 / EN 61008-1	2** ± 5	3KA	4,000			
Supports and plates	EN 60669-1	-	-	-	-	70	650

\* For rated voltages and currents, see the specifications for the individual codes. \*\* The value of 2 MΩ refers to a special condition established by the Standards given alongside.

## Characteristics of screw terminals

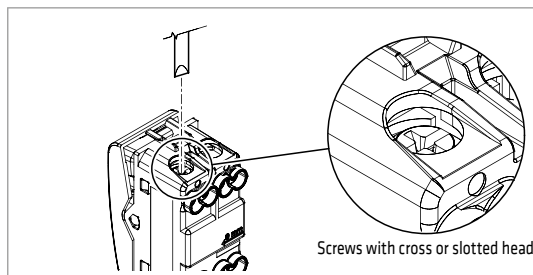

The terminals, located in the rear part of the devices, are manoeuvrable even after coupling the component to the support, and are suitable for both flexible and rigid cables. The components are supplied with the screws of the terminals open, to reduce wiring times.

TECHNICAL DATA			
Terminal grip on cable traction		>50N	
TERMINAL TIGHTENING CAPACITY			
Stranded wires		Solid wires	
Minimum 0.75 mm <sup>2</sup>	Maximum 2x4 mm <sup>2</sup>	Minimum 0.5 mm <sup>2</sup>	Maximum 2x2.5 mm <sup>2</sup>



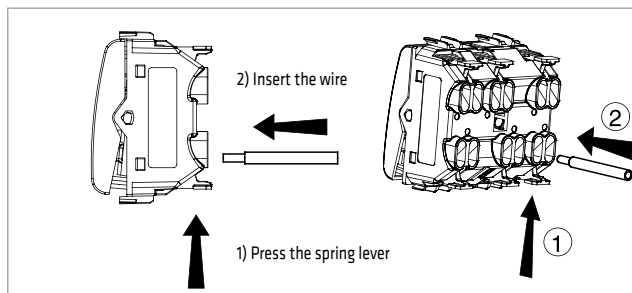





## Characteristics of spring terminals (quick wiring)



The spring terminals allow you to carry out the wiring in a shorter time, and without using screwdrivers or other tools. To insert the cable, it is necessary to press the orange lever (opening of terminal). Releasing the lever, the terminal closes automatically, firmly blocking the cable.

TECHNICAL DATA			
Terminal grip on cable traction		>50N	
TERMINAL TIGHTENING CAPACITY			
Stranded wires		Solid wires	
Minimum 0.75 mm <sup>2</sup>	Maximum 2x4 mm <sup>2</sup>	Minimum 0.5 mm <sup>2</sup>	Maximum 2x2.5 mm <sup>2</sup>

**Combination of modular devices and plates**

Plates		Modular devices							
		Conventional commands	Electronic push-buttons	Touch commands	Socket-outlets / other devices	Touch command modules			
						Conventional	KNX	KNX with interchangeable symbols	
ONE		✓	✓	✓	✓	-	-	-	
GEO		✓	✓	✓	✓	-	-	-	
LUX		✓	✓	✓	✓	-	-	-	
ART		✓	✓	✓	✓	-	-	-	
ICE	ICE		✓	✓	✓	✓	-	-	-
	ICE Touch (1, 2 or 3 printed symbols)		-	-	-	-	✓	-	-
	ICE Touch KNX (2, 4 or 6 printed symbols)		-	-	-	-	-	✓	-
	ICE Touch KNX		-	-	-	-	-	-	✓

DOMESTIC RANGES

## GEO PLATES

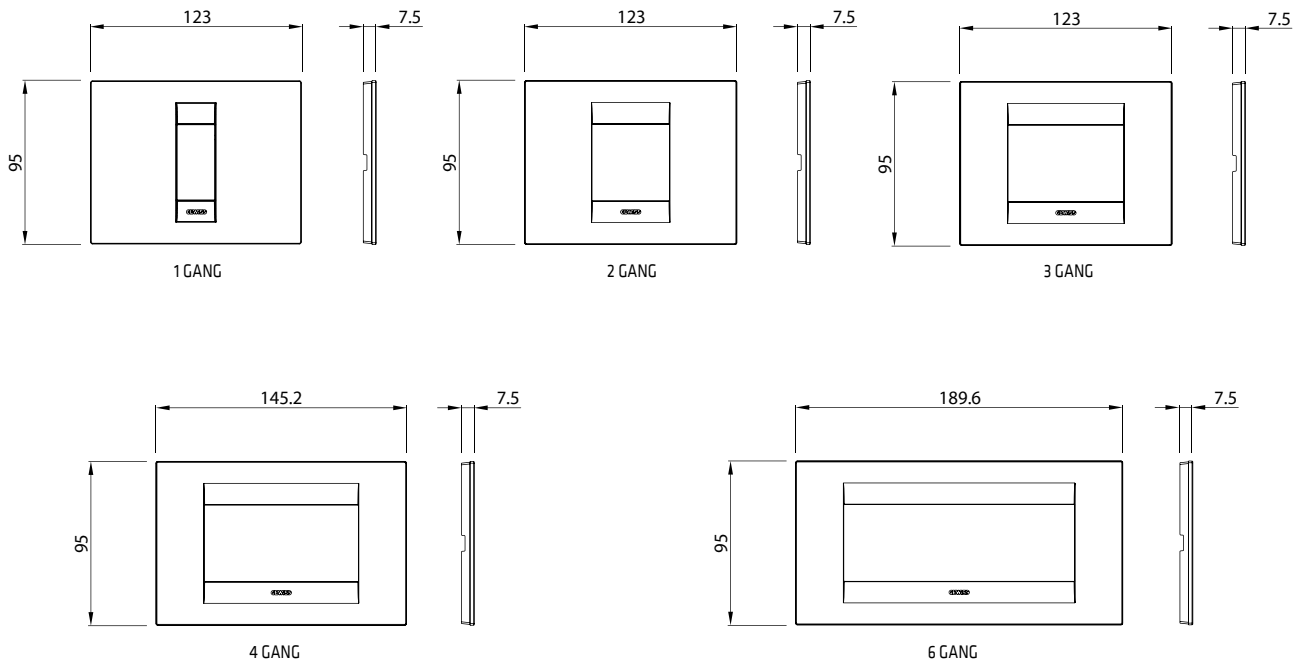

## GEO INTERNATIONAL PLATES

