

# Chorus



GW 12 131

## PUSH-BUTTONS 1P - 250V AC

Code	Description	Button key	Symbol	Pack Carton
<b>No. Chorus modules: 1</b>				
GW 12 131	1P NO - 16A	Neutral		12/96
GW 12 132	1P NO - 16A illuminable	With diffuser		12/24
GW 12 133	1P NO - 16A illuminable	With replaceable neutral lens		12/24
GW 12 136	1P NO - 16A	Pull-cord		1/12
GW 12 137	1P NC - 16A	Neutral	O red	12/24
GW 12 138	1P NC+NO - 16 A	Stop	Red	12/24
GW 12 139	1P NO+NC - 16 A	Start	Green	12/24
GW 12 140	1P NO+NO - 10A	With interlock	UP - DOWN	12/24
GW 12 141	1P NO+NO - 16 A	Double		12/24
GW 12 142	1P NO - 16A illuminable	Green diffuser		12/24
GW 12 143	1P NO - 16A illuminable	Red diffuser		12/24
GW 12 144	1P NO - 16A illuminable	Opal diffuser		12/24
GW 12 151	1P NO - 16A illuminable	With replaceable neutral lens	Light	12/24
GW 12 152	1P NO - 16A illuminable	With replaceable neutral lens	Key	12/24
GW 12 153	1P NO - 16A illuminable	With replaceable neutral lens	Bell	12/24
<b>No. Chorus modules: 1/2</b>				
GW 12 161	1P NO - 10A	Neutral		6/24
GW 12 162	1P NO - 10A illuminable	With diffuser		6/24
<b>No. Chorus modules: 2</b>				
GW 12 171	1P NO - 16A	Neutral		6/24
GW 12 172	1P NO - 16A illuminable	With diffuser		6/24
GW 12 173	1P NO - 16A illuminable	With replaceable neutral lens		6/24
<b>No. Chorus modules: 3</b>				
GW 12 181	1P NO - 16A	Neutral		4/12
GW 12 182	1P NO - 16A illuminable	With diffuser		4/12
GW 12 183	1P NO - 16A illuminable	With replaceable neutral lens		4/12

**CHARACTERISTICS:** the illuminable articles use LED signalling units, not included.

GW12136 Cord in insulating material, 140cm long, with red knob.

GW12140 Button with mechanical interlock. Both contacts are open in the central position (OFF); advisable for activating motorised devices with direction reversal (e.g. roller-shutters, curtains, etc.).

GW12141 independent push-buttons that can also be activated simultaneously.



GW 12 134

## PUSH-BUTTONS 2P - 250V AC

Code	Description	Button key	Symbol	Pack Carton
<b>No. Chorus modules: 1</b>				
GW 12 134	2P NO - 16A	Neutral	O	12/24
GW 12 135	2P NO - 10A illuminable	With replaceable neutral lens		12/24
GW 12 145	2P NO - 10A	With key		1/12

**CHARACTERISTICS:** the illuminable articles use LED signalling units, not included.

**NOTES:** GW12145 equipped with 2 keys. Spare keys: GW30912.



GW 12 191

## PUSH-BUTTONS 1P WITH ILLUMINATED NAME PLATE - 250V AC

Code	Description	Lamp voltage	Lamp	Lamp power	Pack Carton
<b>No. Chorus modules: 2</b>					
GW 12 191	1P NO - 10A	12-24V ac/dc	Cartridge lamp S6x36 mm	2 W	6/24
<b>No. Chorus modules: 3</b>					
GW 12 192	1P NO - 10A	12-24V ac/dc	Cartridge lamp S6x36 mm	2 W	4/16

**CHARACTERISTICS:** lamp not included.

**ONE PLATES**

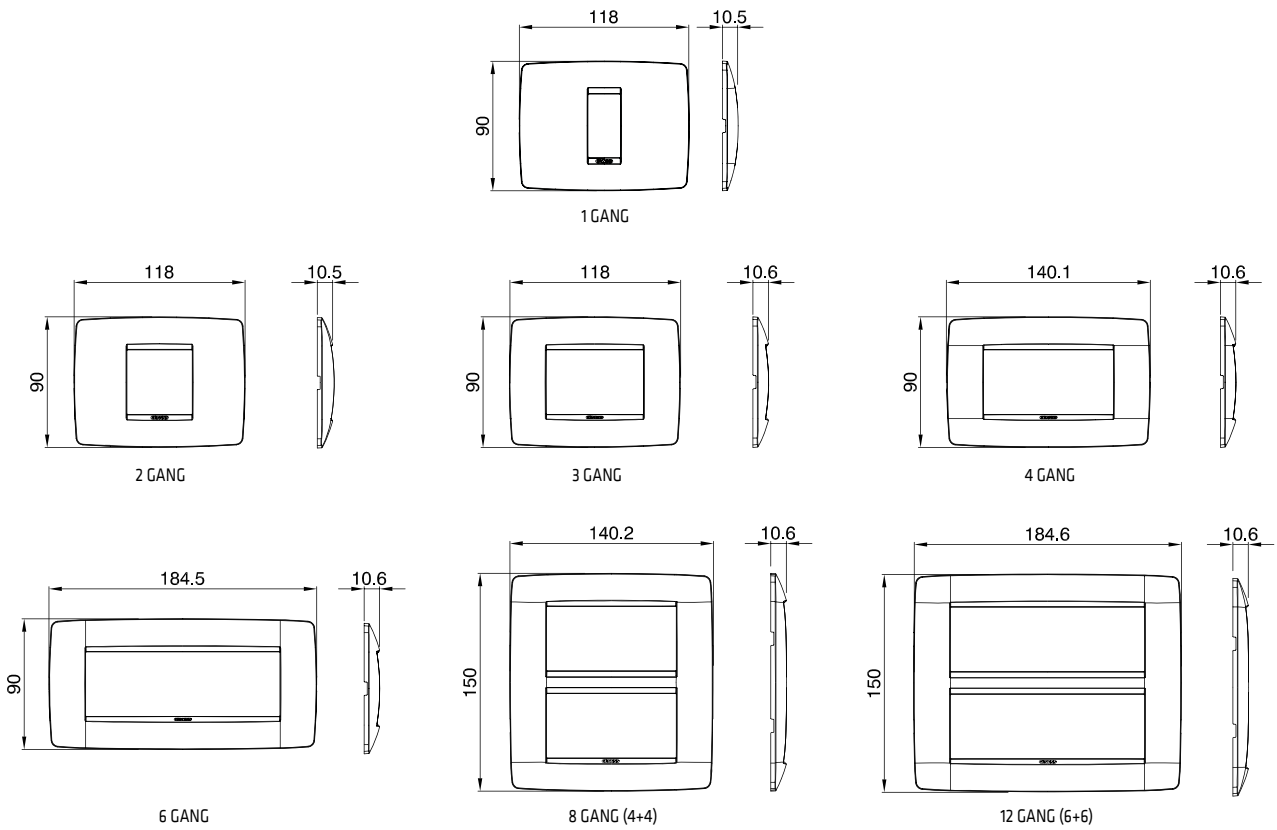

**ONE INTERNATIONAL PLATES**

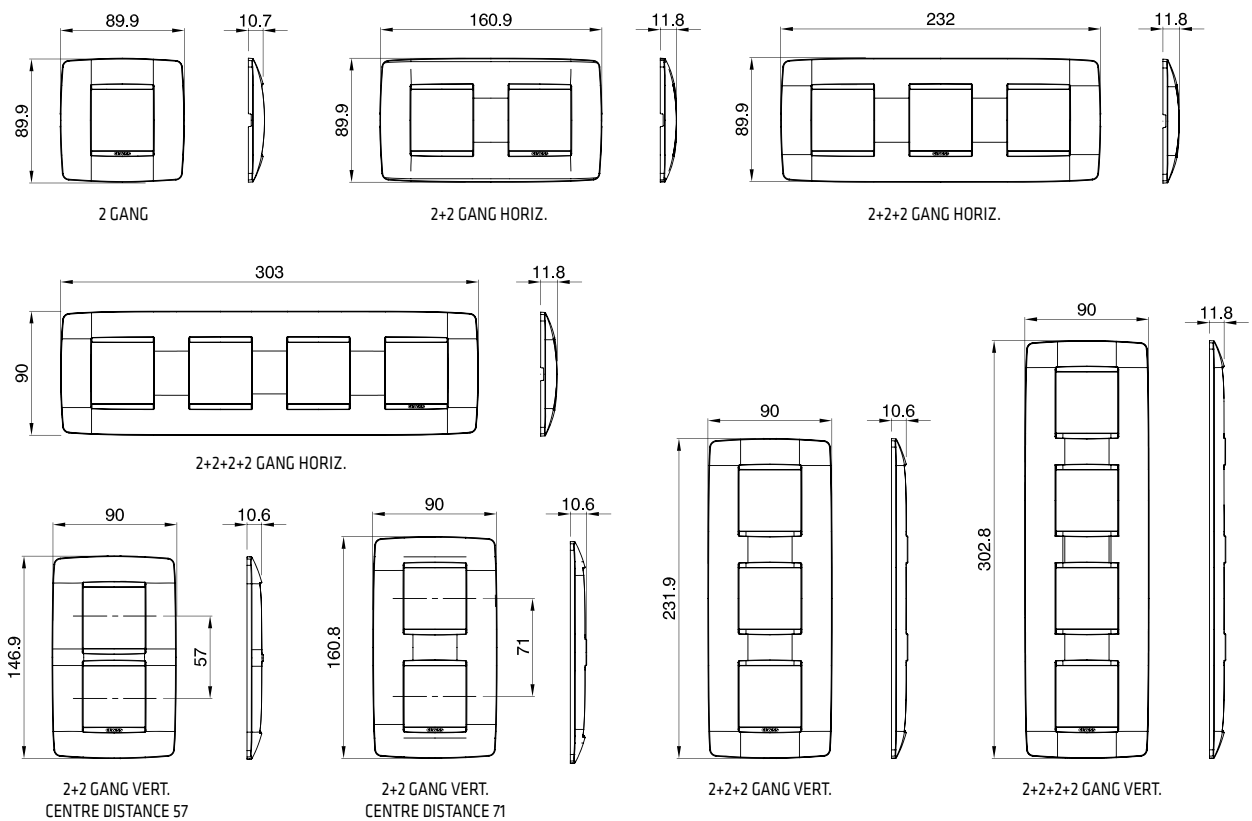

## GEO PLATES

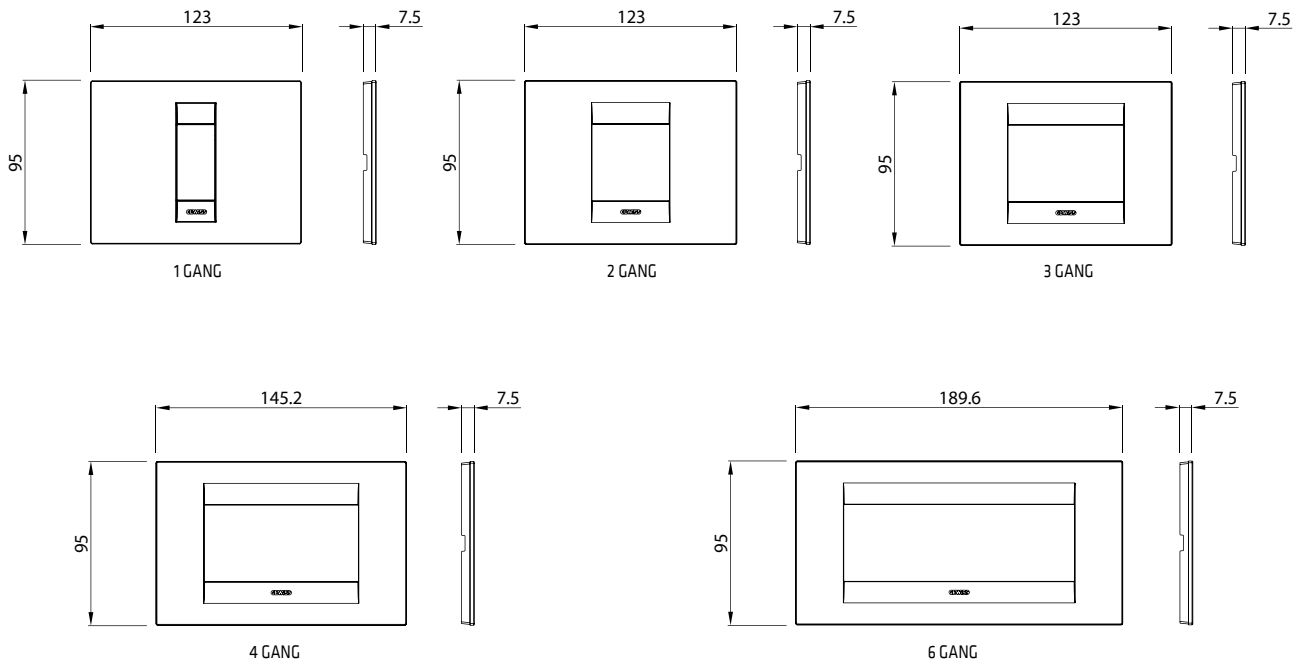

## GEO INTERNATIONAL PLATES

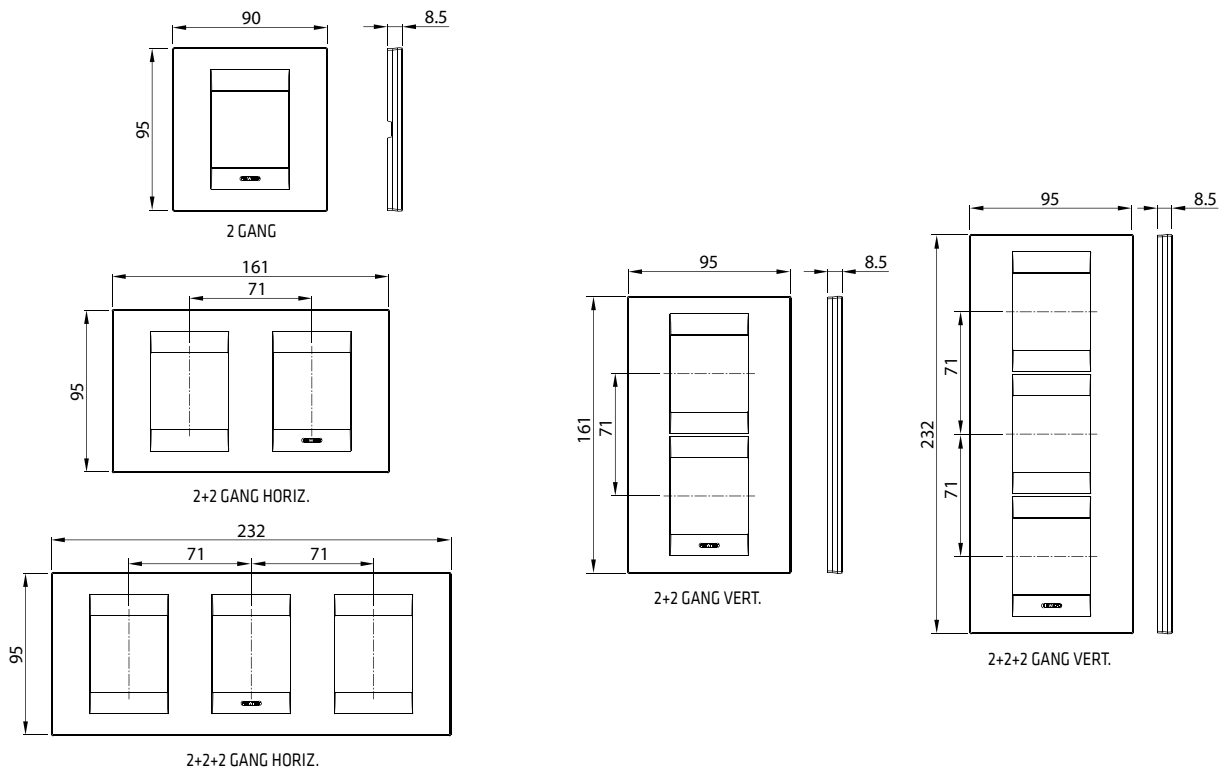

**LUX PLATES**

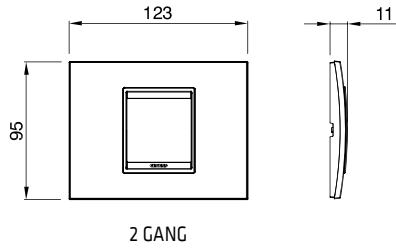

2 GANG

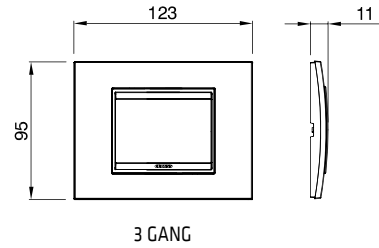

3 GANG

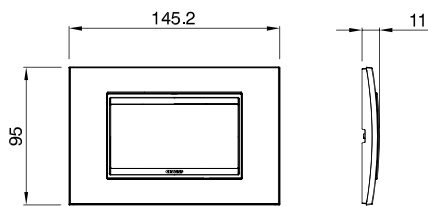

4 GANG

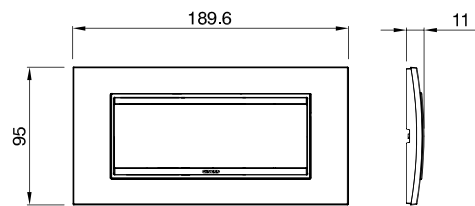

6 GANG

DOMESTIC RANGES

**LUX INTERNATIONAL PLATES**

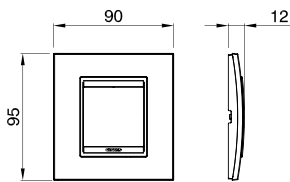

2 GANG

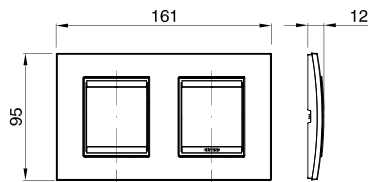

2+2 GANG HORIZ.

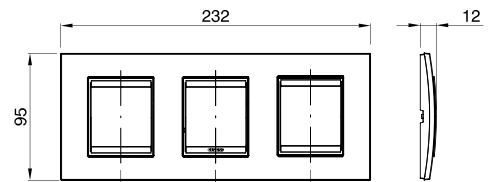

2+2+2 GANG HORIZ.

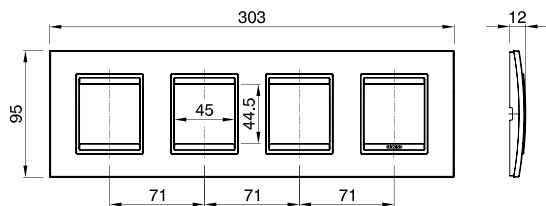

2+2+2 GANG HORIZ.

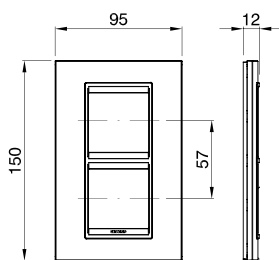

2+2 GANG VERT.  
CENTRE DISTANCE 57

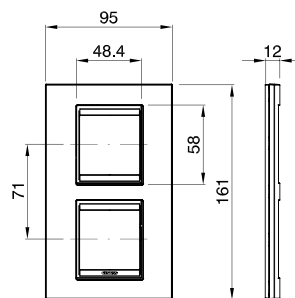

2+2 GANG VERT.  
CENTRE DISTANCE 71

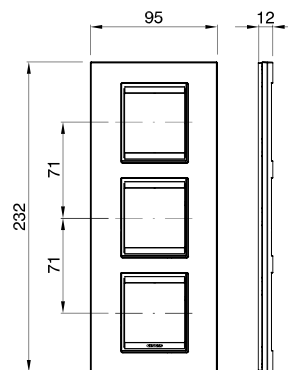

2+2+2 GANG VERT.

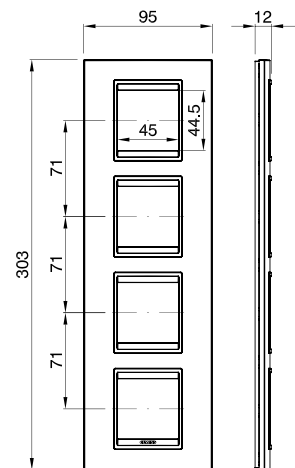

2+2+2 GANG VERT.