

ALLES AN EINER STELLE UND MEHR
ALL IN ONE PLACE AND MORE

THERMOSTAT HEIZUNG / KÜHLUNG 5A 230V~

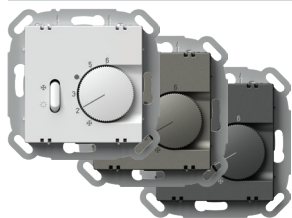

- EQ36PWXO
- EQ36TIXO
- EQ36ATXO

- Betriebsart: Heizung / Kühlung
- Versorgung: 230 V~, 50 Hz
- Ausgang: 2 A (max. 5 A), 230 V~, 50 Hz
- Ausgang: Umschalter (max. 5 Aktoren)
- Regulierungsbereich: +5 °C bis +30 °C
- Hysterese: 0,5 K
- Schutzart: IP30
- Sensorart: bimetal
- elektrischer Anschluss: Steckklemmen
- Leitung Typ: 0,75–1,5 mm² (Weichdraht) oder 1,0–2,5 mm² (Hartdraht)

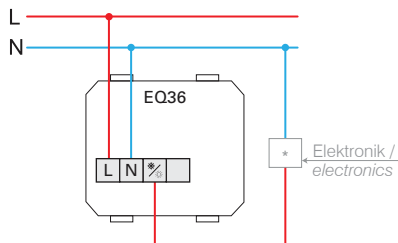

THERMOSTAT HEATING / COOLING 5A 230V~

- operation mode: heating / cooling
- power supply: 230 V~, 50 Hz
- output: 2 A (max. 5 A), 230 V~, 50 Hz
- switching contact: changeover switch (toggler, max. 5 actuators)
- regulation range: +5 °C to +30 °C
- hysteresis: 0,5 K
- protection: IP30
- sensor type: bimetal
- type of electrical connection: spring-loaded contacts
- type of conductors: 0,75 – 1,5mm² (flexible-stranded core) or 1,0 – 2,5 mm² (solid core)

THERMOSTAT BODENHEIZUNG 16A 230V~

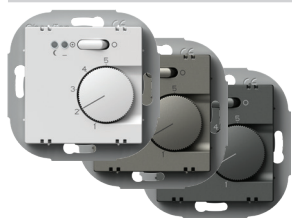

- EQ37PWXO
- EQ37TIXO
- EQ37ATXO

- Betriebsart: Bodenheizung
- Versorgung: 230 V~, 50 Hz
- Ausgang: 2 A (max. 16 A), 230 V~, 50 Hz
- Regulierungsbereich: +10 °C bis +50 °C
- Hysterese: 1 K
- Schutzart: IP30
- Sensorart: NTC nach DIN EN 60730-2-1
- Indikator: rote LED für Heizung ein, grüne LED für reduzierten Nacht-Modus
- elektrischer Anschluss: Schraubklemmen
- Leitung Typ: 0,5–2,5 mm²

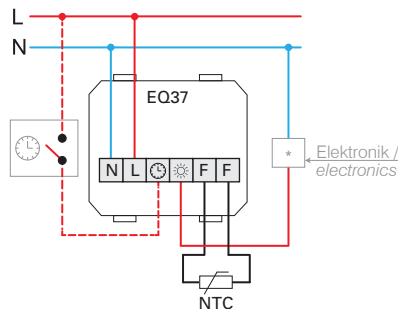

THERMOSTAT FLOOR HEATING 16A 230V~

- operation mode: floor heating
- power supply: 230 V~, 50 Hz
- output: 2 A (max. 16 A), 230 V~, 50 Hz
- regulation range: +10 °C to +50 °C
- hysteresis: 1 K
- protection: IP30
- sensor type: NTC in compliance with DIN EN 60730-2-1
- indicators: Red LED for heating and green LED for night decrease mode
- type of electrical connection: Screw contacts
- type of conductors: 0,5 – 2,5mm²

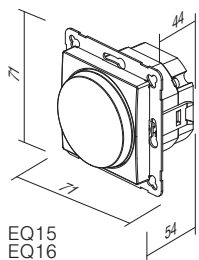

EQ15
EQ16
EQ19

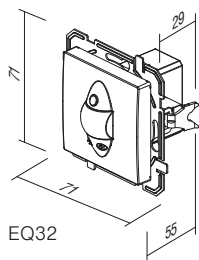

EQ32

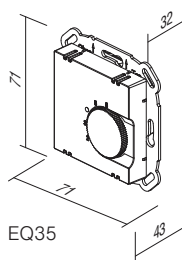

EQ35

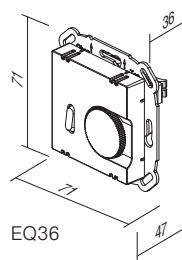

EQ36

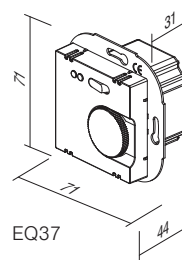

EQ37