

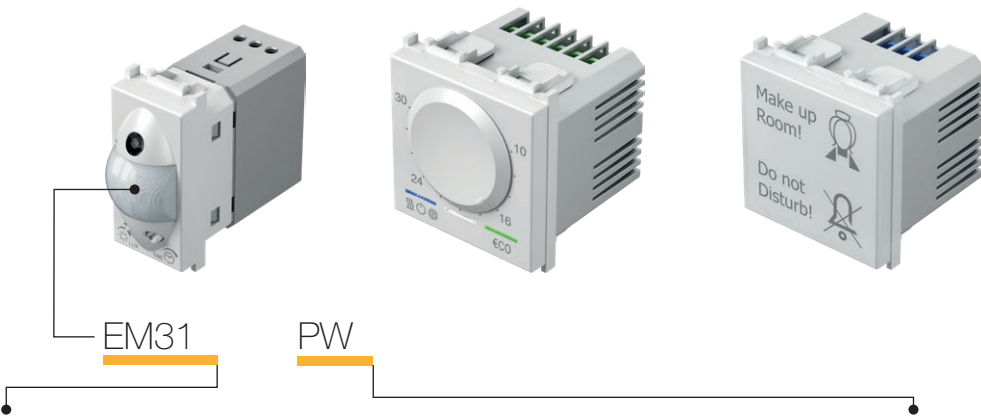

configurator de întrerupătoare și prize configurator of switches and sockets

Modul Manager vă permite să efectuați un inventar complet și rapid al necesarului de prize și întrerupătoare din casa dumneavoastră sau chiar din șantier. Am elaborat o metodă unică de comandă, practică și rapidă în același timp. Puteți selecta culorile întrerupătoarelor, precum și forma ramelor, și astfel le puteți adapta la spațiul propriu sau la solicitările clienților. Încercați-ne! Aveți nevoie doar de un smartphone, o tabletă, sau un calculator și <http://modulmanager.tem.si>.

The Modul Manager allows you to perform a complete and quick inventory of switches from the building site itself or from the comfort of your own home. We have prepared a unique ordering method, which is both practical and quick. You can select the colours of the switches, as well as the shape of the frames, meaning you can tailor them to your space or the client's demands. Why not try us out? All you need is a smartphone, a tablet, or a computer and <http://modulmanager.tem.si>.



tip type	descriere description	date tehnice technical data	mărime size	culoare colour
EM10	VARIATOR ROTATIV DIMMER ROTATIVE	R 300W	1M	<input type="checkbox"/> PW alb polar white
EM12	VARIATOR ROTATIV CAP SCARĂ DIMMER ROTATIVE 2WAY	RL 300W	1M	<input type="checkbox"/> SB negru mat soft touch black
EM23	VARIATOR ÎNCORPORAT DIMMER INBOX	RC,RL 200VA	/	<input type="checkbox"/> AT antracit anthracite
·	·	·	·	<input type="checkbox"/> ES argintiu elox silver
·	·	·	·	<input type="checkbox"/> IW fildeș ivory white
·	·	·	·	<input type="checkbox"/> BL albastru blue
·	·	·	·	<input type="checkbox"/> RD roșu red
·	·	·	·	<input type="checkbox"/> GR verde green
·	·	·	·	<input type="checkbox"/> OR portocaliu orange
·	·	·	·	<input type="checkbox"/> RG roșu/verde red/green

VARIATOR ROTATIV R 300W 1M



- EM10PW
- EM10SB
- EM10AT
- EM10ES
- EM10IW

- variator rotativ fără întrerupător
- tip RTS34.43 RVP, sarcină R, 40W - 300W
- tensiune de alimentare 230V~ 50Hz
- nu se poate combina cu întrerupător cap scară
- nu este permisă combinarea mai multor variatoare
- în conformitate cu EN 60669-1
- borne cu șurub 1,5-2,5mm²
- indicator LED



DIMMER ROTATIVE R 300W 1M

- rotation control without switch
- type RTS34, 43 RVP, load R, 40W - 300W
- supply voltage 230V~ 50Hz
- 2-way switch combination is not possible
- more dimmers combination is not allowed
- in accordance with EN 60669-1
- screw contacts 1.5-2.5mm²
- LED indication

VARIATOR ROTATIV/CAP SCARĂ RL 300W 1M



- EM12PW
- EM12SB
- EM12AT
- EM12ES
- EM12IW

- control rotație cu întrerupător cap scară
- sarcină RL, 40W - 300W
- tensiune de alimentare 230V~ 50Hz
- se poate combina cu întrerupător cap scară
- instalarea mai multor dispozitive într-o singură doză este permisă doar dacă sarcina lor maximă totală nu depășește puterea maximă a unui singur variator
- un circuit permite utilizarea unui singur variator
- fără siguranță încorporată - trebuie să se utilizeze siguranță externă
- în conformitate cu EN 60669-1
- borne cu șurub - 1,5-2,5mm²
- indicare LED integrată a nivelului de variere



DIMMER ROTATIVE/2WAY RL 300W 1M

- rotation control with 2-way switch
- load RL, 40W - 300W
- supply voltage 230V~ 50Hz
- 2-way switch combination is possible
- installing several devices together in one box is only permitted if their total maximum load does not exceed the maximum power of a single dimmer
- one circuit allows the use of only one dimmer
- no built-in fuse - external fuse must be used
- in accordance with EN 60669-1
- screw contacts - 1.5-2.5mm²
- integrated LED indication of dimming level

COMPONENTE ELECTRONICE EM

EM10 (40÷300W)
EM15 (40÷250W)

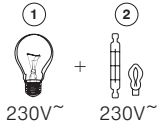

EM12 (40÷300W)

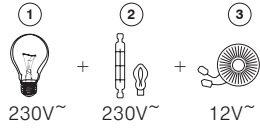

EM13 (0÷60W), EM14 (0÷180W),
EM23 (15÷250W, 15÷200VA),
EM18 (2÷250VA (3=10÷250VA), 2÷250W)

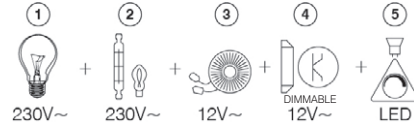

- 1 - bec incandescent / incandescent lamp
- 2 - bec halogen / halogen lamp
- 3 - transformator clasic / classical transformer
- 4 - transformator electronic de estompare / dimmable electronic transformer
- 5 - bec LED cu intensitate variabilă / dimmable LED lamp

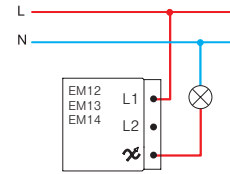
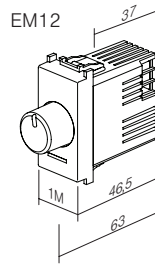
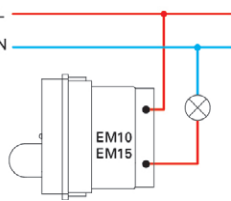
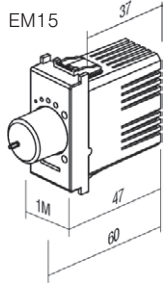
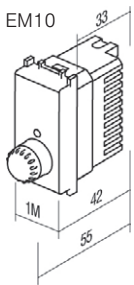

EM23

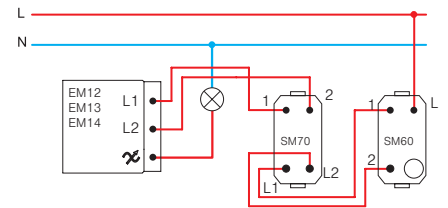
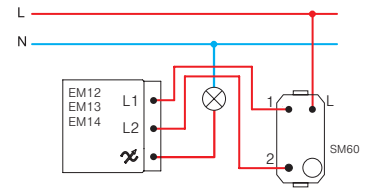
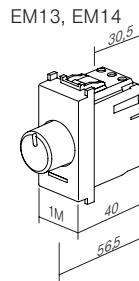
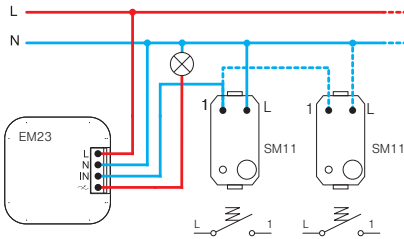
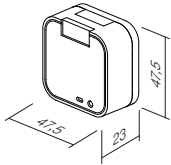

EM18

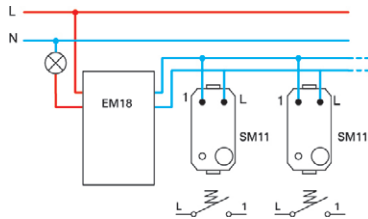
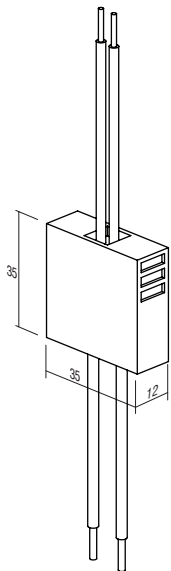

EM19

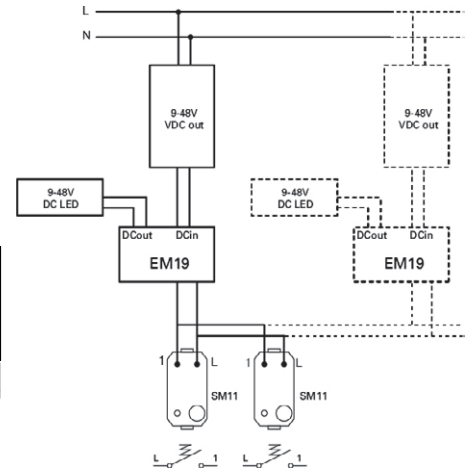
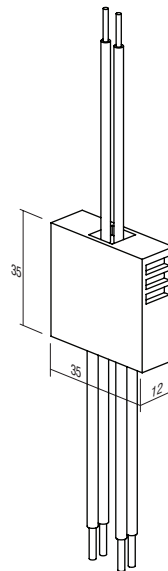

ATENȚIE!

În cazul în care sunt conectate mai multe variatoare într-o singură doză, se reduce puterea comună maximă cu 10% pentru fiecare variator

ATTENTION!

If more dimmers are connected in one box reduce maximum common power for 10% for each dimmer.

