

# SMART Energy meters

7M  
SERIES



Panels for electrical distribution



Control panels



Electrical energy control



Industrial robots



Road / tunnel lighting



Elevators and lifts



**Single-phase Bi-directional energy meters with backlit LCD display  
Multi-function and MID certified**

**Type 7M.24.8.230.0010  
S0 pulse output**

**Type 7M.24.8.230.0110 (with NFC)  
S0 pulse output, IR communication port  
NFC technology allows reading the measured energy even in the absence of mains voltage and to program and customize the counters via smartphone**

- Display of total or partial (resettable) consumption: kWh, kVAh, kvarh
- 2 active energy MID counters + 2 reactive energy nationally certified counters
- 8 resettable counters
- Scroll to view the following instantaneous values: V, A, PF, kW, kVA, kvar, Hz, THD V, THD A, phase angle and direction of power flow
- 7 digit backlit LCD display
- Multi-function touch button
- Active energy accuracy Class B according to EN 50470-3 (MID)
- Reactive energy accuracy Class 2 to EN 62053-23
- S0 pulse output for remote energy monitoring according to EN 62053-31
- Sealable tamperproof terminal shield
- Protection category II
- 35 mm rail (EN 60715) mount

**NEW 7M.24.8.230.0010**



- Reference current 5 A (40 A Maximum)
- S0 pulse output
- 1-phase 230 V 50/60 Hz
- MID certified

**NEW 7M.24.8.230.0110**



- Reference current 5 A (40 A Maximum)
- S0 pulse output, IR communication port and NFC
- 1-phase 230 V 50/60 Hz
- MID certified

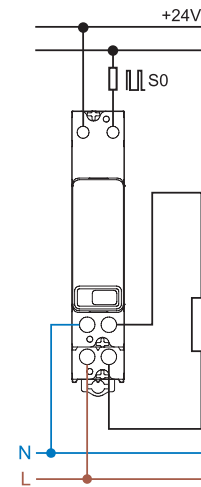
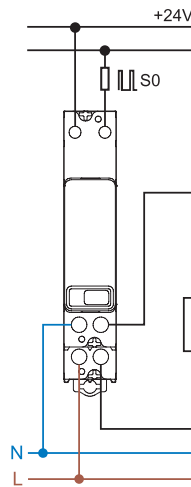

For outline drawing see page 14

**Specification**

Reference/Maximum current $I_N/I_{max}$	A	5/40	5/40
Starting current $I_{st}$	A	0.02	0.02
Minimum measured current $I_{min}$	A	0.25	0.25
Current range (within accuracy class)	A	0.5...40	0.5...40
Maximum peak current	A	1200 (10 ms)	1200 (10 ms)
Supply (& monitored) voltage $U_N$	V AC	230	230
Operating range		$(0.8...1.15)U_N$	$(0.8...1.15)U_N$
Frequency	Hz	50/60	50/60
Power consumption	W/VA	$\leq 0.5/1.5$	$\leq 0.5/1.5$
Display		LCD	LCD
Max. totalising count/Min. increment	kWh	999 999.9/0.1	999 999.9/0.1
LED pulses per kWh		1000	1000
LED pulse length	ms	$4 \pm 0.5$	$4 \pm 0.5$
<b>Output specification (S0+/S0-)</b>			
Number/Type		1 opto-isolated output	1 opto-isolated output
Voltage range/Maximum current (conforming to EN 62053-1)	V DC/mA	3.3...27/1...27	3.3...27/1...27
Pulses per kWh	Imp/kWh	1000	1000
Pulse length	ms	$32 \pm 2$	$32 \pm 2$
Maximum cable length	m	1000	1000
<b>Technical data</b>			
Accuracy class IEC EN 50470-3 / IEC EN 62053-23		1/2	1/2
Ambient temperature (Within accuracy class) °C		-25...+55	-25...+55
Protective class		II	II
Protection category: Housing/terminals		IP 50/IP 20	IP 50/IP 20
<b>Approvals (according to type)</b>		<b>CE</b>	

### Ordering information

Example: 1-phase energy meter for direct connection up to 40 A, S0 pulse output, Class B accuracy, for 35 mm rail (EN 60715) mounting, with integral sealable tamperproof terminal shield.

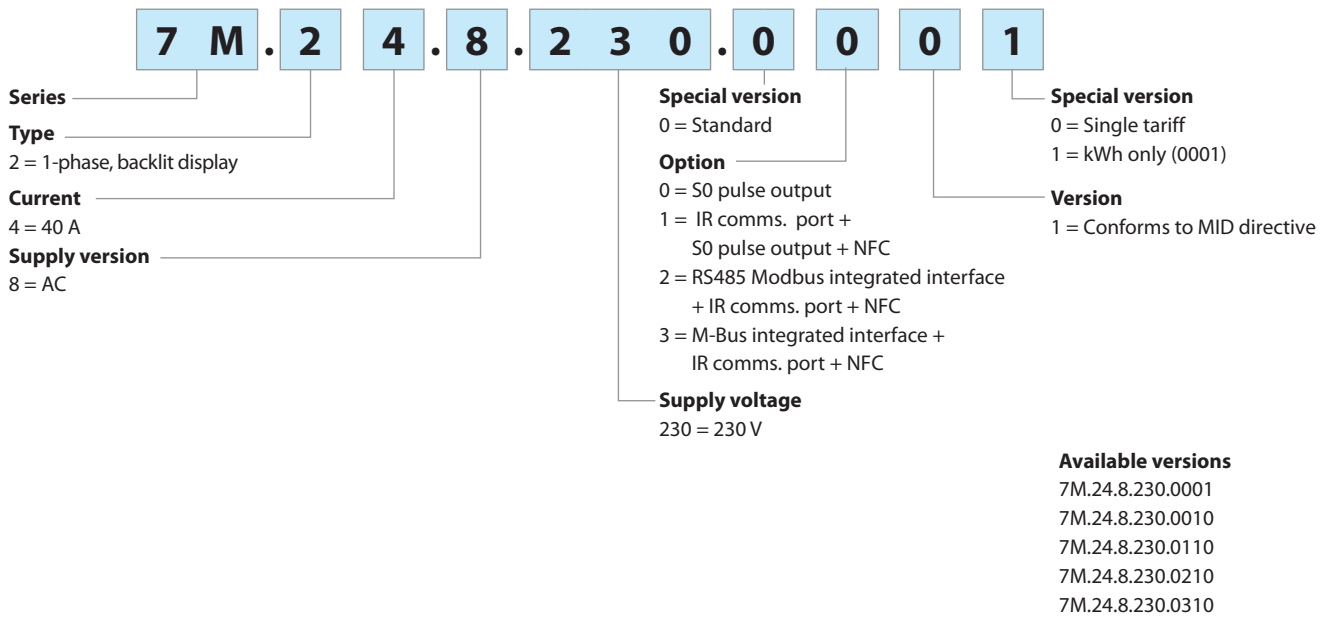

Example: 3-phase energy meter for direct connection up to 80 A, with MID certification, Class B accuracy, for 35 mm rail (EN 60715) mounting.

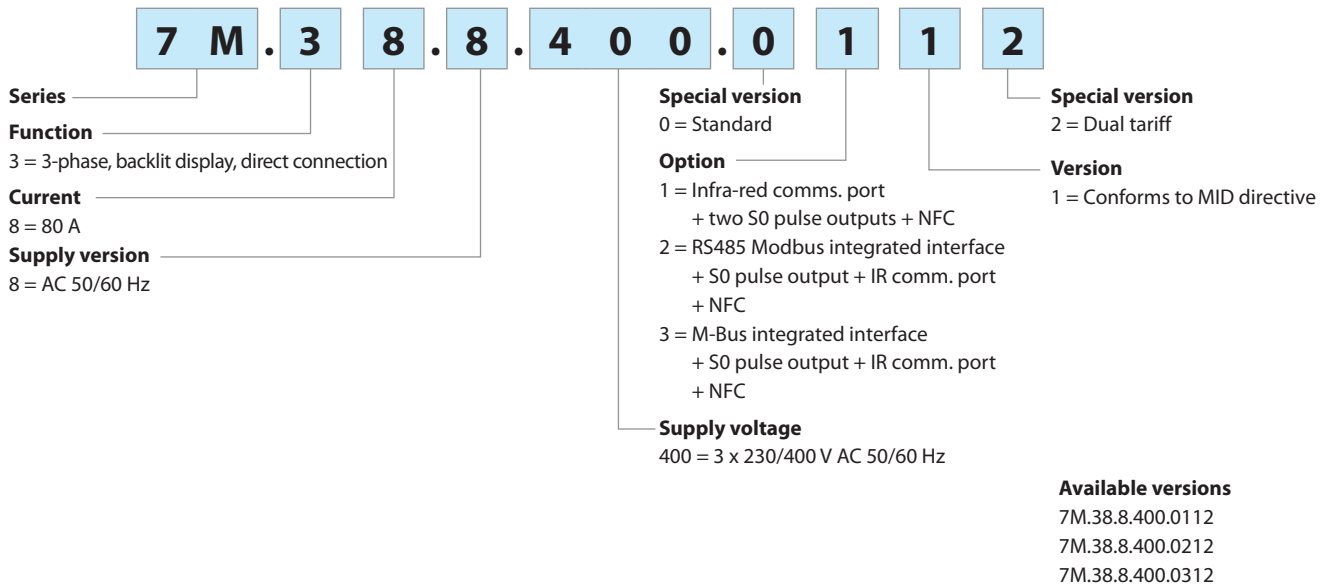

## Technical data

Insulation		7M.24.8.230.0xxx		7M.38.8.400.0xxxx	
Insulation rated voltage		V 250		250	
Insulation	between active parts and S0+/S0- terminals	kV (1.2/50 µs)		6	
	between supply and Modbus, M-Bus terminal	kV (1.2/50 µs)		6	
	between adjacent phases	kV (1.2/50 µs)		6	
Insulation	between active parts and S0+/S0- terminals	V AC		4000	
	between supply and Modbus, M-Bus terminal	V AC		4000	
Protection class				II	
EMC Specification according to 61000-4-(2/3/4)		7M.24.8.230.0xxx		7M.38.8.400.0xxxx	
Electrostatic discharge	contact discharge			8 kV	
	air discharge			15 kV	
Radio frequency Electromagnetic field (80...2000)MHz				30 V/m	
Fast Transients (burst) (5-50 ns, 5 kHz)	on Supply terminals			4 kV	
	on S0+/S0- terminals			2 kV	
	Modbus, M-Bus terminal			2 kV	
Surge (1.2/50 µs)	on Supply terminals			4 kV	
Other data		7M.24.8.230.0xxx		7M.38.8.400.0xxxx	
Pollution degree				2	
Vibration resistance		EN 60068-2-6		EN 60068-2-6	
Shock resistance		EN 60068-2-27		EN 60068-2-27	
Power lost to the environment		max value per phase		0.5W/1.5 VA	
				1W/7.5VA	
Supply terminals		7M.24.8.230.0xxx		7M.38.8.400.0xxxx	
Max. wire size		solid cable	stranded cable	solid cable	stranded cable
	mm <sup>2</sup>	1.5...10	1.5...10	1.5...25	1.5...25
	AWG	16...8	16...8	16...4	16...4
Screw torque for I <sub>max</sub>		Nm	0.8	0.8	3.5
				3.5	3.5
S0+/S0- terminals, RS485 Modbus, M-Bus		7M.24.8.230.0xxx		7M.38.8.400.0xxxx	
Max. wire size		solid cable	stranded cable	solid cable	stranded cable
	mm <sup>2</sup>	0.14...2.5	0.14...2.5	0.14...2.5	0.14...2.5
	AWG	26...14	26...14	26...14	26...14
Screw torque		Nm	0.6	0.6	0.6

## Two programming modes for energy meters with NFC technology

### “Smart”

Smart mode via smartphones with NFC communication using Finder toolbox NFC, iOS or Android App.

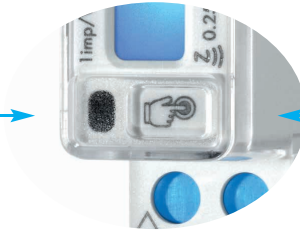

### “Classic”

Classic mode via touch button to scroll and read the meter

Android, Google Play and the Google Play logo are trademarks of Google Inc.  
Apple is a trademark of Apple Inc. App Store is a service mark of Apple Inc.

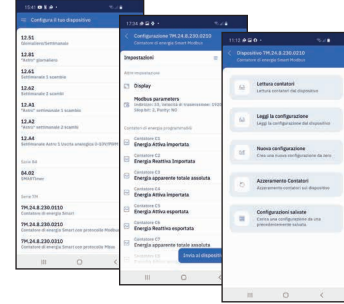

E

### Finder Toolbox NFC App for programming

Once the FINDER Toolbox NFC App is downloaded and installed, you can easily program your device thanks to NFC technology. One of the main features is that even in the absence of the power supply network, it is possible to read an energy counter, read the existing configuration, change the communication protocol parameters, or save and share the settings.

All that is required for the transfer of data is to simply touch the device with the smartphone.

### Finder Toolbox for information

Finder Toolbox can provide you with all the latest technical data sheets and news from Finder.

## Example using the NFC Toolbox APP

### Reading Counters

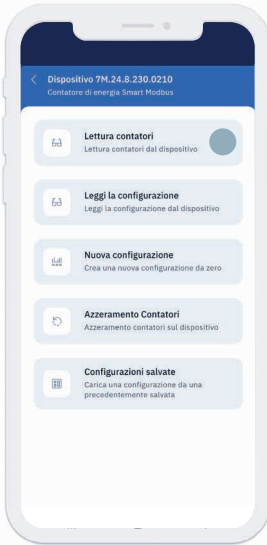

If you want to read all the energy counters select **"Read Counters"**



Even in the absence of the power supply network all the measurements made are readable thanks to the App - not just MID values.

### Modbus parameter settings

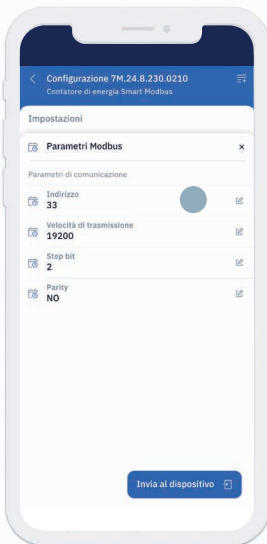

Select **"Address"** in order to change default values

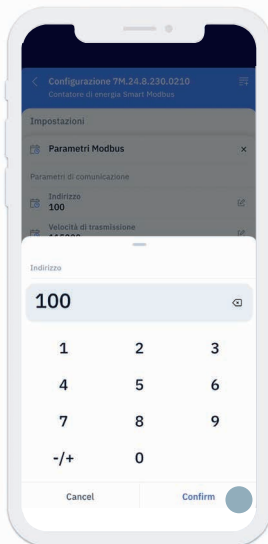

write the new address: **100**.  
Click **"Confirm"**

### Saved configuration

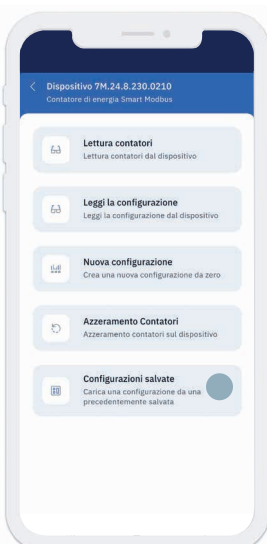

Recall the stored configuration

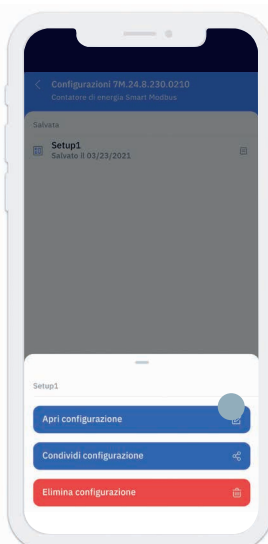

## Outline drawings

Type 7M.24.8.230.0001

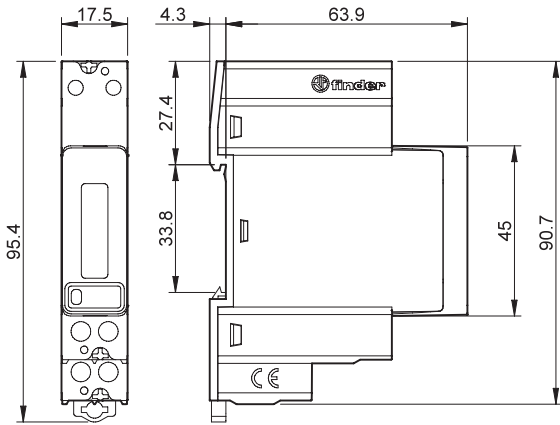

Type 7M.24.8.230.0010

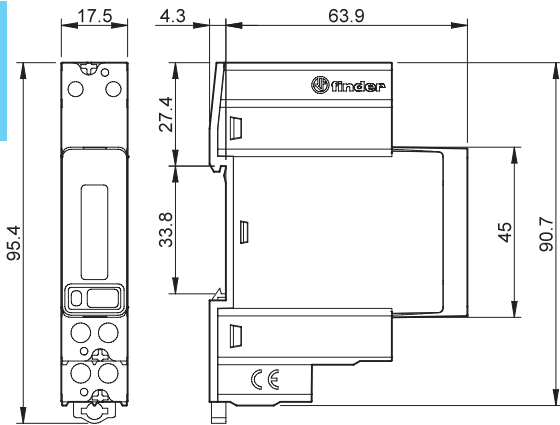

Type 7M.24.8.230.0110

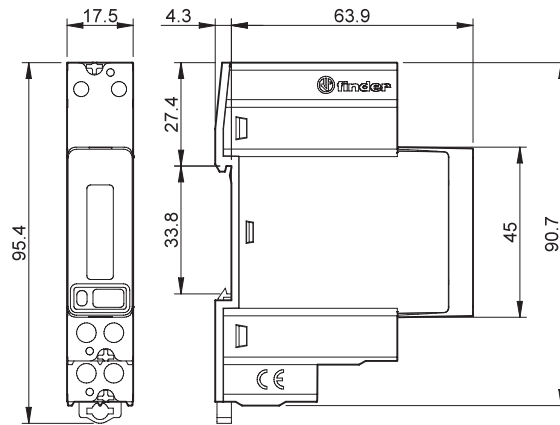

Type 7M.24.8.230.0210

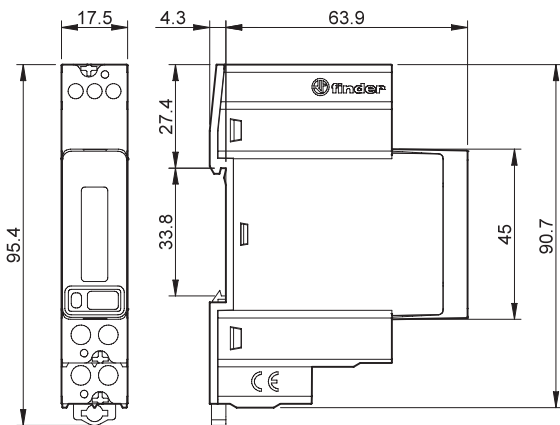

Type 7M.24.8.230.0310

