

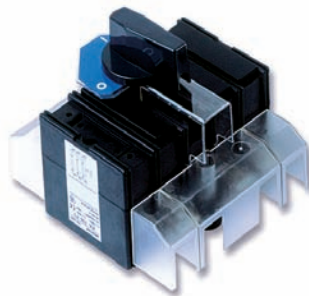

RA100P3/OHB  
+cable terminal shrouds



RA100P3/R  
+cable terminal shrouds



RAB1P3/OHY  
+fuse link shroud



RAB2P3/OHY  
+fuse link shroud

**R** type series is divided into two groups:

- RA switch disconnectors
  - 3-pole with optional neutral (N) 4th pole
  - RA100 - 4th pole switchable
- RAB switch disconnectors fuses
  - 3-pole with optional neutral (N) 4th pole
  - RAB000 - 4th pole switchable

## GENERAL INFORMATION

- safety of service and easy installation,
- self-extinguishing thermoplastics (VO flammability class),
- silver plated parts of current circuits,
- self-tightening and self-cleaning contacts,
- high electrical and mechanical endurance,
- high short-circuit making and breaking capacity,
- double, safe clearance between open contacts,
- complete isolation of fuse links in „off” position,
- manually operated drive (spring powered),
- wide range of accessories.

## APPLICATIONS

Switch disconnectors series **R** are designed for distribution of electricity and protection against short circuits and overloads in three phase alternative current circuits. They can be used as:

- main switch disconnector in distribution boards,
- switch disconnector,
- switch disconnector for motor control and protection.

## OPERATING CONDITIONS

- to be installed in the room free of any dust, aggressive or explosive gases,
- for moderate, marine and tropical climate,
- ambient temperature from -25°C to +55°C,
- altitude up to 2000 meters above sea level,
- outdoor – in cabinets with protection degree > IP 34.

Table 127. RAB switch disconnectors fuses with „A” type cable terminals

Type	I <sub>n</sub>	Number of poles	Accessories*	Article	Article No.
RAB 000	100 A	3	-	RAB 000 P3 A	kofigurator
		3 + N	-	RAB 000 P3 NA	63-823063-101
		4	-	RAB 000 P4 A	63-823063-061
		3	R1	RAB 000 P3 A/R	on request
		3 + N	R1	RAB 000 P3 NA/R	on request
		4	R1	RAB 000 P4 A/R	on request
RAB 00	160 A	3	-	RAB 00 P3 A	on request
		3 + N	-	RAB 00 P3 NA	on request
		3	R1	RAB 00 P3 A/R	on request
		3 + N	R1	RAB 00 P3 NA/R	on request
RAB 1	250 A	3	-	RAB 1 P3 A	on request
		3 + N	-	RAB 1 P3 NA	on request
		3	R1	RAB 1 P3 A/R	on request
		3 + N	R1	RAB 1 P3 NA/R	on request
RAB 2	400 A	3	-	RAB 2 P3 A	on request
		3 + N	-	RAB 2 P3 NA	on request
		3	R1	RAB 2 P3 A/R	on request
		3 + N	R1	RAB 2 P3 NA/R	on request
RAB 3	630 A	3	-	RAB 3 P3 A	on request
		3 + N	-	RAB 3 P3 NA	on request
		3	R1	RAB 3 P3 A/R	on request
		3 + N	R1	RAB 3 P3 NA/R	on request

\*R1 - handle mounted on shaft

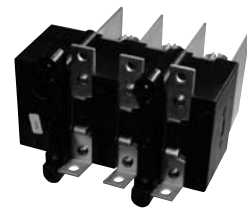
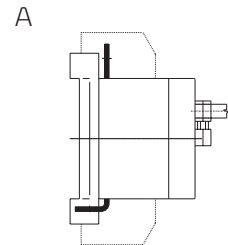

RAB 00 P3 A

Table 128. RAB switch disconnectors fuses with „B” type cable terminals

Type	I <sub>n</sub>	Number of poles	Accessories*	Article	Article No.
RAB 000	100 A	3	-	RAB 000 P3 B	on request
		3 + N	-	RAB 000 P3 NB	63-823063-111
		3 + N	-	RAB 000 P4 B	63-823063-071
		3	R1	RAB 000 P3 B/R	on request
		3 + N	R1	RAB 000 P3 NB/R	on request
		4	R1	RAB 000 P4 B/R	on request
RAB 00	160 A	3	-	RAB 00 P3 B	on request
		3 + N	-	RAB 00 P3 NB	on request
		3	R1	RAB 00 P3 B/R	on request
		3 + N	R1	RAB 00 P3 NB/R	on request
RAB 1	250 A	3	-	RAB 1 P3 B	on request
		3 + N	-	RAB 1 P3 NB	on request
		3	R1	RAB 1 P3 B/R	on request
		3 + N	R1	RAB 1 P3 NB/R	on request
RAB 2	400 A	3	-	RAB 2 P3 B	on request
		3 + N	-	RAB 2 P3 NB	on request
		3	R1	RAB 2 P3 B/R	on request
		3 + N	R1	RAB 2 P3 NB/R	on request
RAB 3	630 A	3	-	RAB 3 P3 B	on request
		3 + N	-	RAB 3 P3 NB	on request
		3	R1	RAB 3 P3 B/R	on request
		3 + N	R1	RAB 3 P3 NB/R	on request

\*R1 - handle mounted on shaft

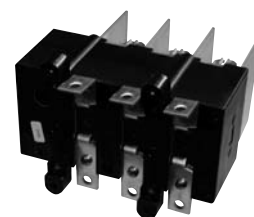
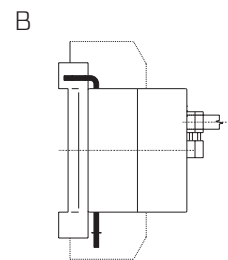

RAB 00 P3 B

### Dimensions of RAB 000 (100 A)

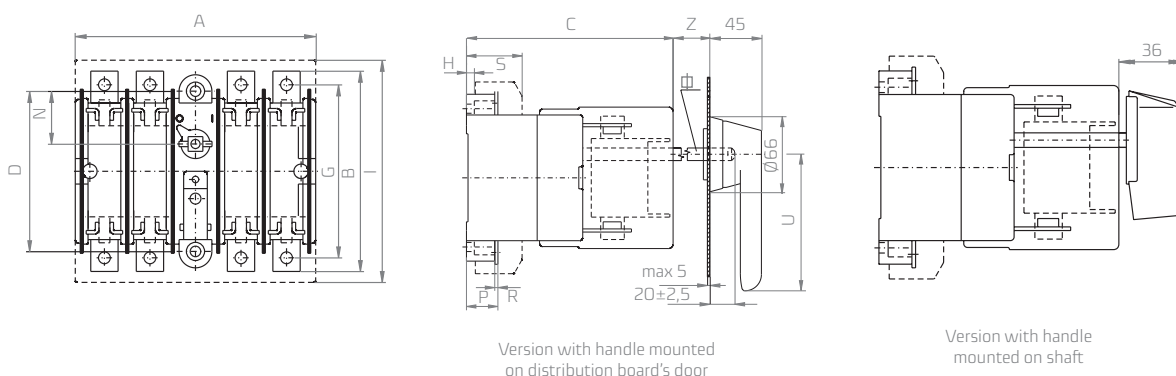

Dimension [mm]	A	B	C	D	E	G	H	I	L	M	N	O	P	R	S	U	Z	∅	W
RAB 000	132	110	132	88	-	95	5	150	-	-	29	-	20	2	50	65	20	8	-

### Dimensions of RAB 00, RAB 1, RAB 2, RAB 3

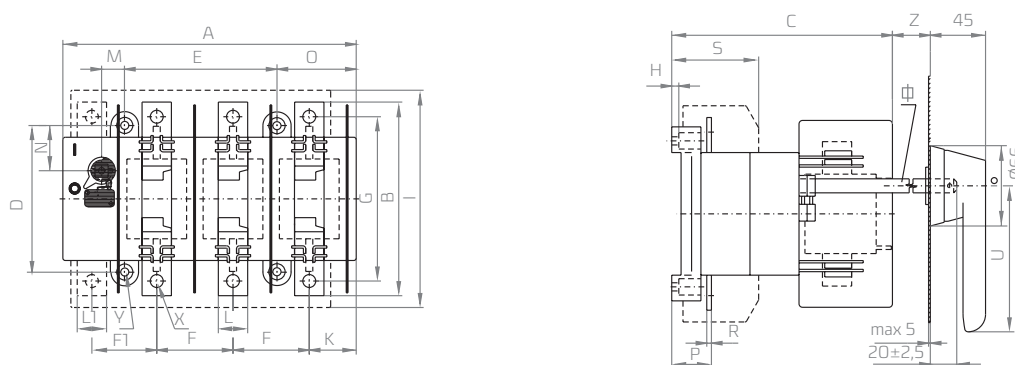

Dimension [mm]	A	B	C	D	E	F	F1	G	H	I	K	L	L1	M	N	O	P	R	S	U	X	Y	Z	∅	W	
RAB 00	176	132	150	110	84	42	42	115	5	170	30	20	20	16	36	51	26	3,5	61	95	8,5	5,8	15	10	20	
RAB 1		250	174	189	125	130	65	55	149	8	225	40	25	25	20	38,5	67,5	34	4	86	125	11	7	15	12	25
RAB 2																		30	5							
RAB 3	300	240	215	170	160	80	70	200	8	270	45,5	40	30	19	56,5	83	40	6	97	145	13	7	20	12	-	

### Cable terminals of type A, B, C

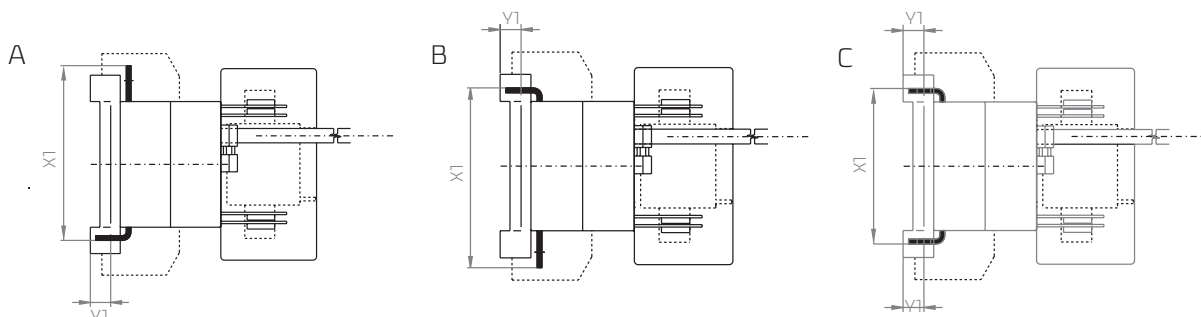

Dimensions of cable terminals [mm]	RAB 00			RAB 1			RAB 2		
	A	B	C	A	B	C	A	B	C
X1	111	111	90	140,5	140,5	116	146	146	127
Y1	8,5	8,5	8,5	8,5	8,5	8,5	13	13	13

**CAUTION!**  
lengthening of shaft is possible by adding second shaft, connected by shaft link (see Accessories)

Dimensions of RA switch disconnectors, RAB switch disconnectors fuses (with cable terminals of type A, B, C) with side support element for mounting

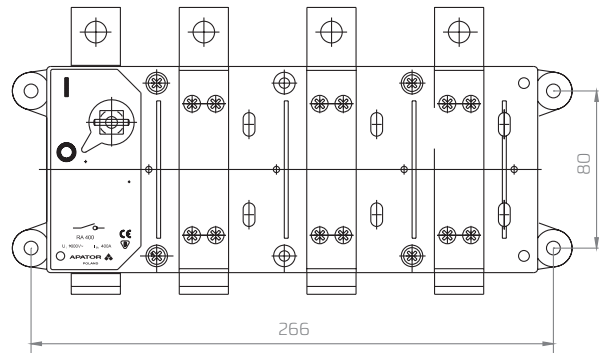
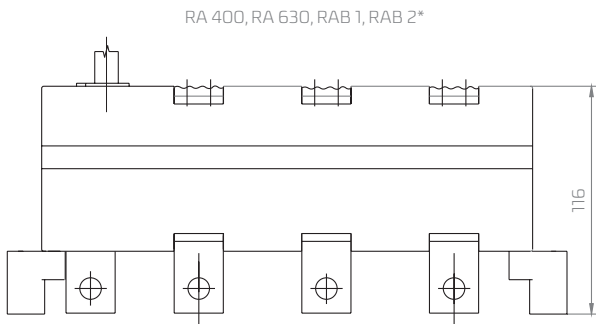
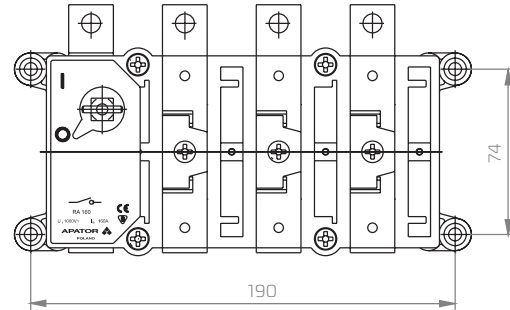
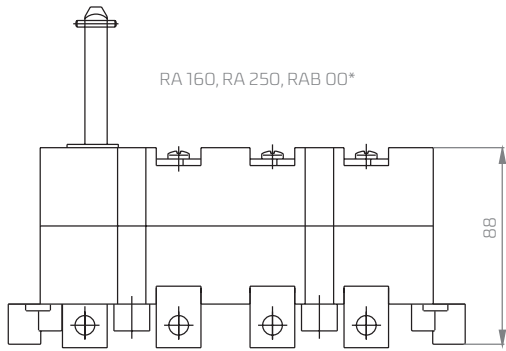

\* ordered with switch

L-minimal distance between shaft and door's hinge

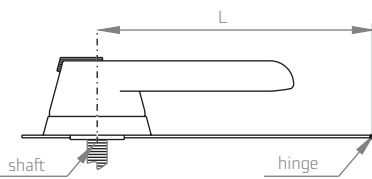

hole in enclosure's cover or door for mounting of OHB handles

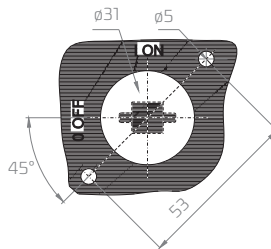

Switch disconnector	Length [mm]	Handle
RA 100	80	OH...65 J8
RAB 000	80	OH...65 J8
RA 160/250	120	OH...95 J10
RAB 00	120	OH...95 J10
RA 400/630	150	OH...125 J12
RAB 1/2	150	OH...125 J12
RAB 3	200	OH...145 J12
RA 1250	200	OH...175 J12