

## RBK 2 pro (400 A, 690 V)

Table 95. Technical data

Parameter		RBK 2 pro / RBK 2 pro-S		
Rated thermal current $I_{th}$	A	400		
Napięcie znamionowe $U_n$	V	690		
Utilization category	-	AC-23B	DC-22B	DC-21B
Rated switching current $I_e$	A	400	400	400
Rated switching voltage $U_e$	V	690	220	440
Rated short circuit making current	690 V	kA	80	20/250V, 15/440V
	500 V			
	400 V		100	
Rated short circuit withstand current	690 V	kA	80	20/250V, 15/440V
	500 V		-	
	400 V		100	
Rated insulation voltage $U_i$	V	1000		
Rated impulse withstand voltage $U_{imp}$	kV	12		
Rated frequency	Hz	50-60	-	
Mechanical durability	Number of cycles	1000		
Electrical durability	Number of cycles	200		
IP degree of protection	IP	20		
Weight	kg	~3, ~4,5		
Size of fuse links	-	2		









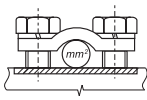
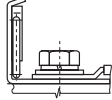
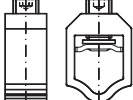
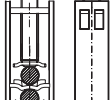

RBK 2-V pro  
for installation on mounting plate

RBK 2 pro

Table 96. Versions

RBK 2 pro/400 A		Cable terminal	Article No.	
<b>For installation on mounting plate</b>				
RBK 2 pro	for connection of round conductors	S-bridge clamps	63-811685-011	
RBK 2 pro-V	for connection of sector-shaped conductors	V-clamps	63-811685-071	
RBK 2 pro-2V	for connection of sector-shaped conductors	double V-clamps	63-811685-081	
RBK 2 pro-M	or connection of conductors with lug terminals	M10 screws	63-811685-061	
RBK 2 pro-VG	for connection of sector-shaped / round conductors top terminals - V-clamps, bottom terminals - S-bridge clamps	V-clamps / S-bridge clamps	63-811685-201	
RBK 2 pro-VG-M	for connection of sector-shaped conductors / conductors with lug terminals top terminals - V-clamps, bottom terminals - screw terminals	V-clamps / S-bridge clamps	63-811685-202	
RBK 2 pro-VD	for connection of round / sector-shaped conductors top terminals - S-bridge clamps, bottom terminals - V-clamps	V-clamps / S-bridge clamps	63-811685-203	
RBK 2 pro-VD-M	for connection of conductors with lug terminals / sector-shaped conductors top terminals - screw terminals, bottom terminals - V-clamps	screws / V-clamps	63-811685-204	
<b>For installation on to 60 mm busbar system</b>				
APASYS 60	RBK 2 pro-SD-M 60	Bottom cable terminals, for connection of conductors with lug terminals	M10 screws	63-811686-061
	RBK 2 pro-SG-M 60	Top cable terminals, for connection of conductors with lug terminals	M10 screws	63-811686-051
	RBK 2 pro-SD-V 60	Bottom cable terminals, for connection of sector-shaped conductors	V-clamps	63-811686-101
	RBK 2 pro-SG-V 60	Top cable terminals, for connection of sector-shaped conductors	V-clamps	63-811686-091
	RBK 2 pro-SD-2V 60	Bottom cable terminals, for connection of sector-shaped conductors	double V-clamps	63-811686-141
	RBK 2 pro-SG-2V 60	Top cable terminals, for connection of sector-shaped conductors	double V-clamps	63-811686-131
<b>For installation on to 100 mm busbar system</b>				
RBK 2 pro-SD-M 100	Bottom cable terminals, for connection of conductors withlug terminals	M10 screws	63-811686-081	
RBK 2 pro-SG-M 100	Top cable terminals, for connection of conductors with lug terminals	M10 screws	63-811686-071	
RBK 2 pro-SD-V 100	Bottom cable terminals, for connection of sector-shaped conductors	V-clamps	63-811686-121	
RBK 2 pro-SG-V 100	Top cable terminals, for connection of sector-shaped conductors	V-clamps	63-811686-111	
RBK 2 pro-SD-2V 100	Bottom cable terminals, for connection of sector-shaped conductors	double V-clamps	63-811686-161	
RBK 2 pro-SG-2V 100	Top cable terminals, for connection of sector-shaped conductors	double V-clamps	63-811686-151	

Table 94. RBK 2 pro terminal clamps

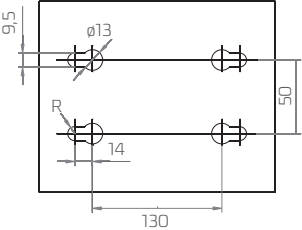
Description	RBK 2 pro			
	Clamp	S-bridge clamp 2 x M8 x 30	M10 x 30 screw	V-clamp 35-300SW-B
Drawing of clamp				
Cross-section of conductors	Cu/Al conductor 50 ÷ 185 mm <sup>2</sup>	conductor with lug terminal up to 240 mm <sup>2</sup>	V-clamp for direct fixing of conductor with bare end with cross-section:	
			35 - 185 mm <sup>2</sup>  35 - 240 mm <sup>2</sup>  35 - 240 mm <sup>2</sup>  35 - 300 mm <sup>2</sup> 	35 - 185 mm <sup>2</sup>  35 - 240 mm <sup>2</sup>  35 - 240 mm <sup>2</sup>  35 - 300 mm <sup>2</sup> 
Cu bar	maximum bar width 35 mm			
Tightening torque	10 Nm*	20 Nm*	30 Nm*	40 Nm*
Dimensions and spacing of holes for installation of RBK 2 on mounting plate				

For stranded conductors using cable ferrules is recommended  
\*using of tension wrench is recommended



**RBK 2 pro-V**  
for installation  
on mounting plate,  
cable terminals: V-clamps



**RBK 2 pro-2V**  
for installation  
on mounting plate,  
cable terminals: double V-clamps



**RBK 2 pro-SG** (top cable terminal: M10 screws)  
**RBK 2 pro-SD** (bottom cable terminal: M10 screws)  
for installation on to busbar systems



**RBK 2 pro-SG-V** (top cable terminal: double V-clamp)  
**RBK 2 pro-SD-V** (bottom cable terminal: double V-clamp)  
for installation on to busbar systems  
cable terminals: V-clamps



**RBK 2 pro-SG-2V** (top cable terminal: V-clamp)  
**RBK 2 pro-SD-2V** (bottom cable terminal: V-clamp)  
for installation on to busbar systems  
cable terminal: double V-clamps

RBK 2 pro

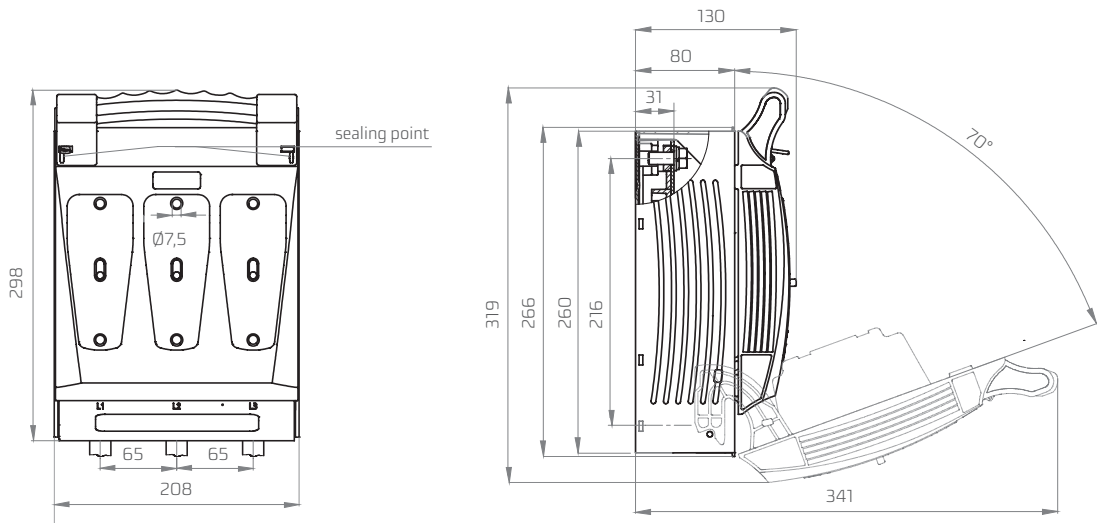

RBK 2 pro-V

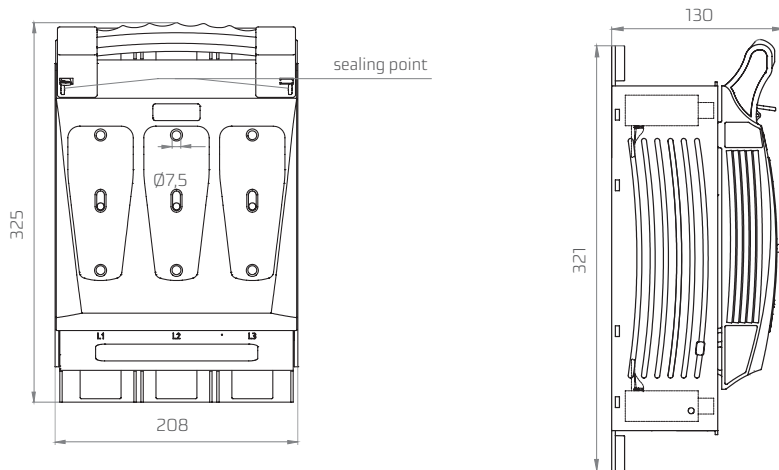

RBK 2 pro-2V

