

■ DELTA line

Universal switches
Titanium white

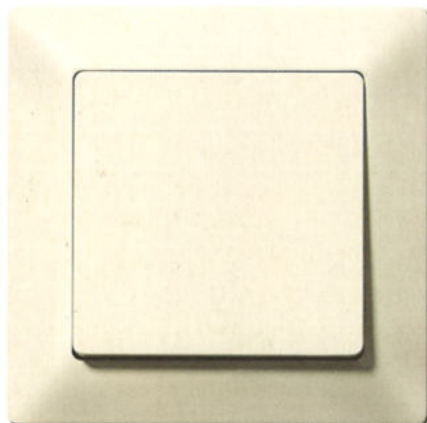

Universal switches
Electrical white

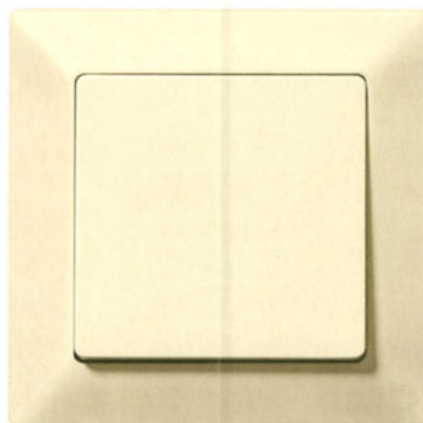

Universal switches
Aluminum metallic

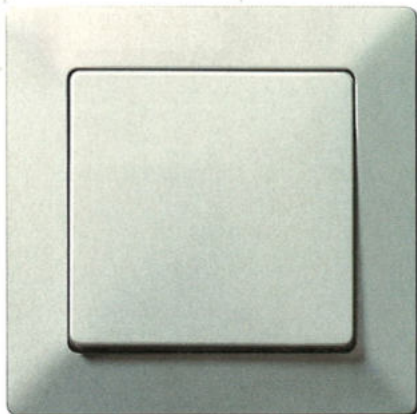

Universal switches
Carbon metallic

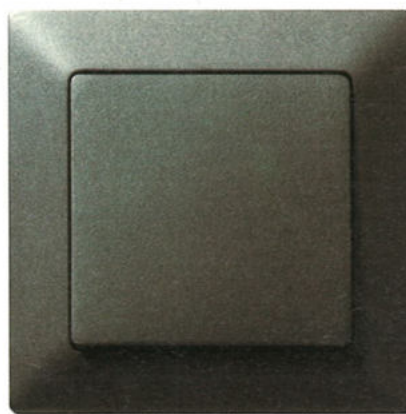

**Components of
the DELTA line product range:**

- Frames in four colors
- Printable frames for horizontal and vertical mounting
- Components of the DELTA i-system product range: operator interfaces, **SCHUKO** socket outlets ...
- Set of seals for rockers and socket outlets provide degree of protection IP44
- Comprehensive functions from the DELTA i-system for:
 - Communication
 - Data and voice networks
 - Shutter/blind control, also with radio remote control (GAMMA wave)
 - Time switches
 - Room temperature control
 - Dimmer control, also with radio remote control (GAMMA wave)
 - Motion detection
 - Can be connected to GAMMA *instabus*

Introduction

Overview

Modular components of the DELTA vita, DELTA i-system, DELTA line and DELTA miro product ranges



Examples of components DELTA vita Frames with color elements



Examples of components DELTA i-system Rockers and socket outlet

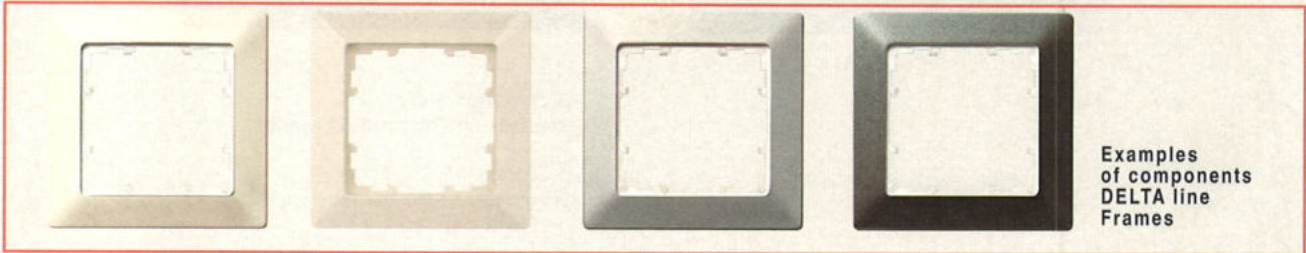

Examples of components DELTA line Frames

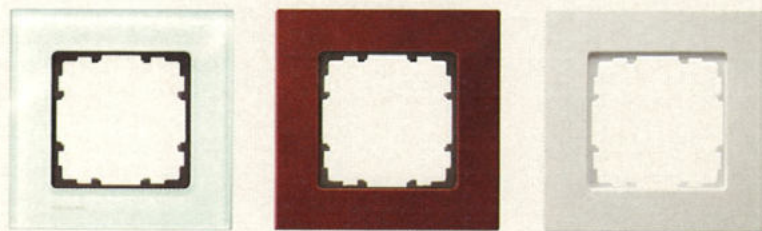

Examples of components DELTA miro Frames

12_10727d

Technical design of the DELTA line product range

Note:
in this section we will be introducing the frames available in the DELTA line product range.

All components of the DELTA i-system product range can be used as central inserts and cover plates.

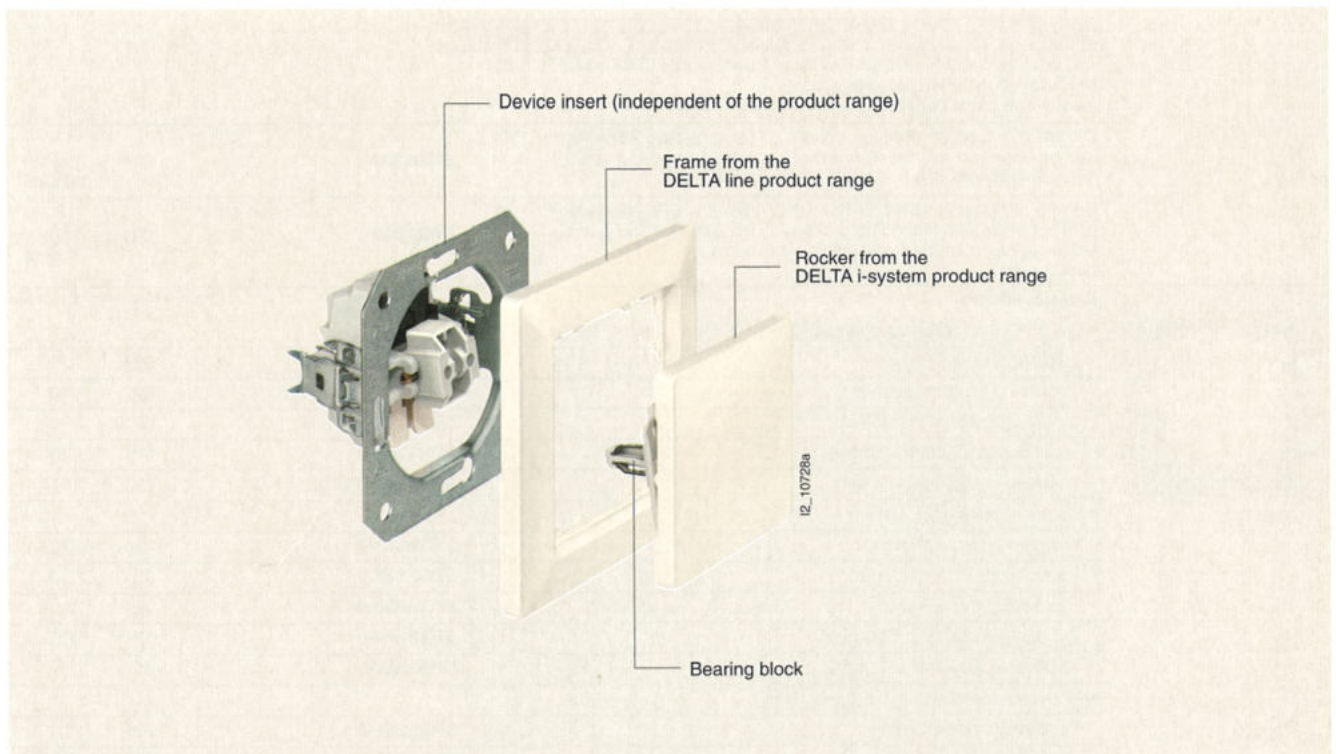

DELTA i-system

Informații generale:

- Montaj în doză cu șurub și gheare
- AC 250 V, 16 A, DC 250 V, 10 V
- IP20, pentru conductoare de Cu sau Al de până la 2,5 mm²

Versiune

Cod comandă



Prize SCHUKO

Alb titan	5UB1511
Crem	5UB1551
Aluminiu metalic	5UB1931
Carbon metalic	5UB1921
Verde	5UB1512
Portocaliu	5UB1513



Priză SCHUKO cu capac

Alb titan	5UB1917
Crem	5UB1907
Aluminiu metalic	5UB1937
Carbon metalic	5UB1927



Priză dublă SCHUKO

Alb titan	5UB2211-3
-----------	-----------



Clapete rotative

Alb titan	5TC8900
Crem	5TC8901
Aluminiu metalic	5TC8902
Carbon metalic	5TC8903