

# ■ DELTA line

**Universal switches**  
Titanium white

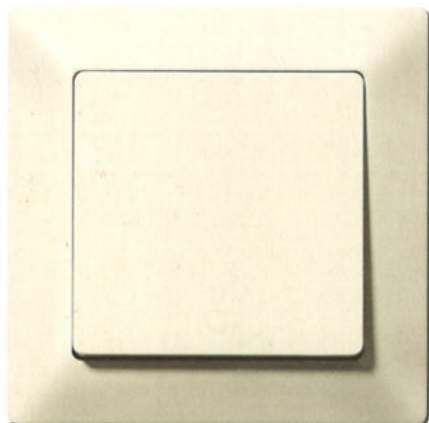

**Universal switches**  
Electrical white

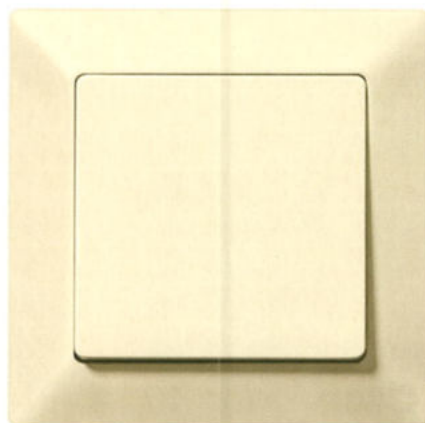

**Universal switches**  
Aluminum metallic

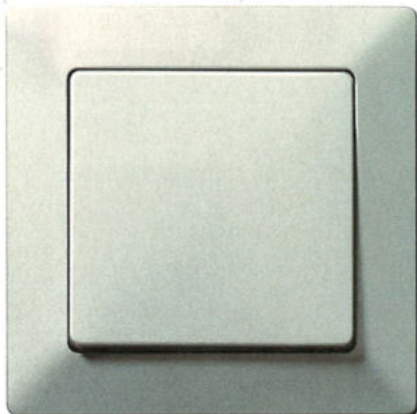

**Universal switches**  
Carbon metallic

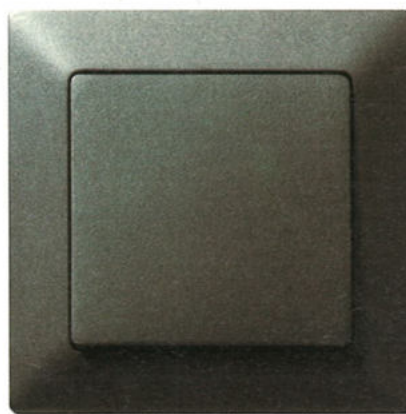

**Components of  
the DELTA line product range:**

- Frames in four colors
- Printable frames for horizontal and vertical mounting
- Components of the DELTA i-system product range: operator interfaces, **SCHUKO** socket outlets ...
- Set of seals for rockers and socket outlets provide degree of protection IP44
- Comprehensive functions from the DELTA i-system for:
  - Communication
  - Data and voice networks
  - Shutter/blind control, also with radio remote control (GAMMA wave)
  - Time switches
  - Room temperature control
  - Dimmer control, also with radio remote control (GAMMA wave)
  - Motion detection
  - Can be connected to GAMMA *instabus*

## Introduction

### Overview

Modular components of the DELTA vita, DELTA i-system, DELTA line and DELTA miro product ranges



Examples of components DELTA vita Frames with color elements



Examples of components DELTA i-system Rockers and socket outlet

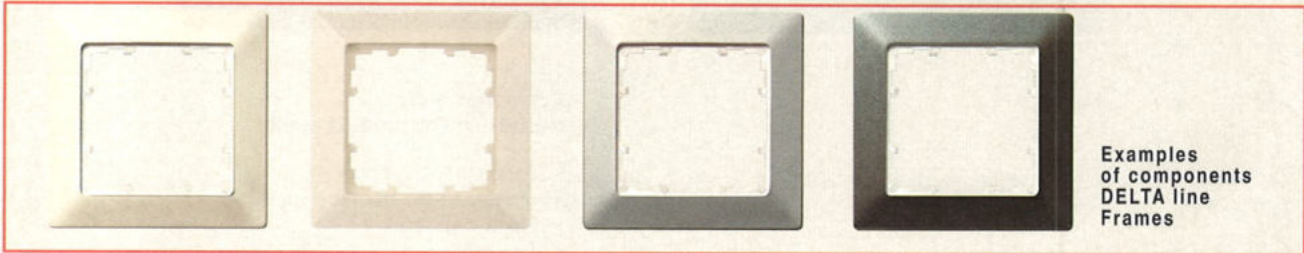

Examples of components DELTA line Frames

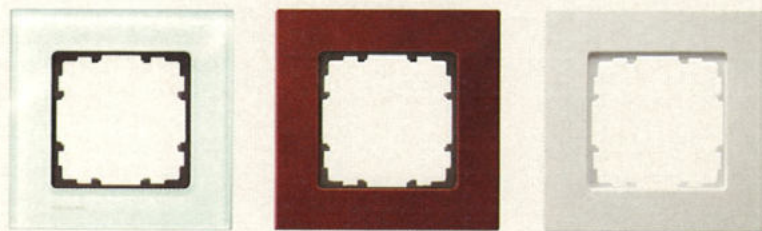

Examples of components DELTA miro Frames

12\_10727d



**Technical design of the DELTA line product range**

Note:  
in this section we will be introducing the frames available in the DELTA line product range.

All components of the DELTA i-system product range can be used as central inserts and cover plates.

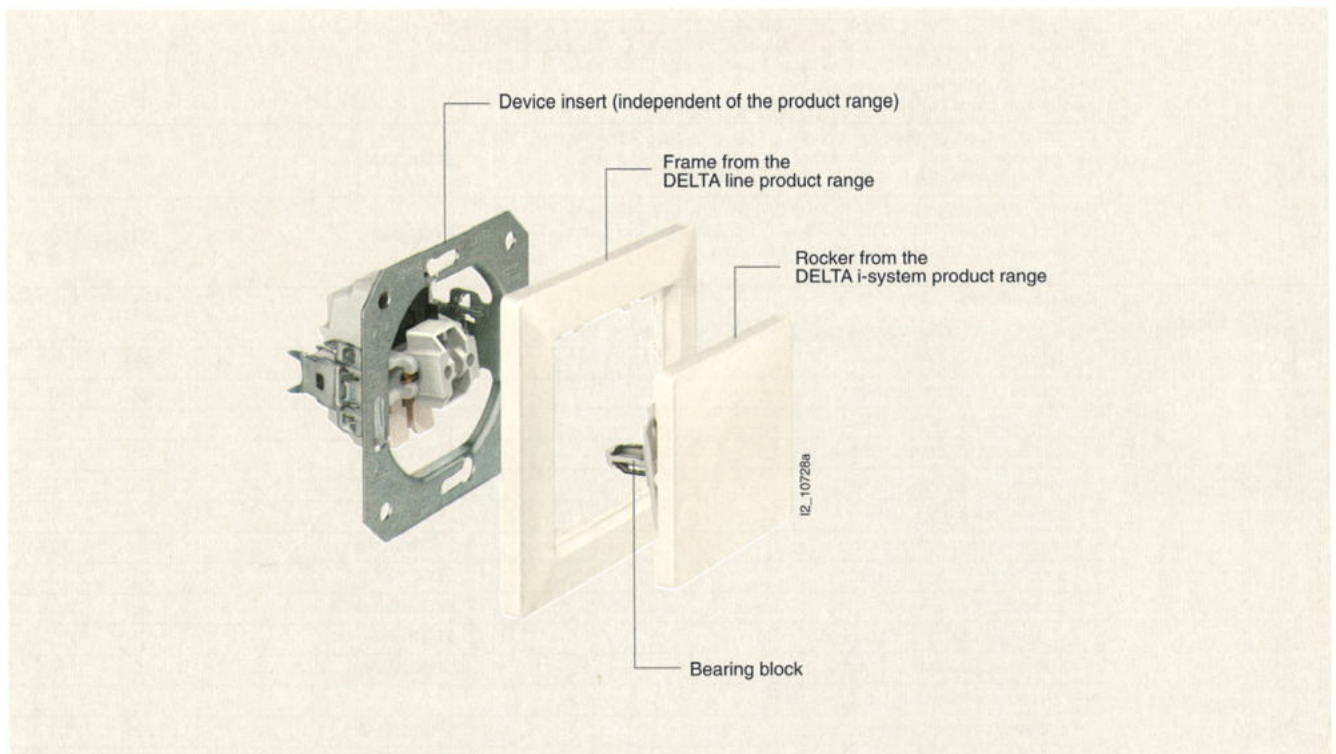

## DELTA i-system

## Informații generale:

- Montaj în doză cu șurub și gheare
- AC 250 V, 16 A, DC 250 V, 10 V
- IP20, pentru conductoare de Cu sau Al de până la 2,5 mm<sup>2</sup>

## Versiune

## Cod comandă



## Prize SCHUKO

Alb titan	5UB1511
Crem	5UB1551
Aluminiu metalic	5UB1931
Carbon metalic	5UB1921
Verde	5UB1512
Portocaliu	5UB1513



## Priză SCHUKO cu capac

Alb titan	5UB1917
Crem	5UB1907
Aluminiu metalic	5UB1937
Carbon metalic	5UB1927



## Priză dublă SCHUKO

Alb titan	5UB2211-3
-----------	-----------



## Clapete rotative

Alb titan	5TC8900
Crem	5TC8901
Aluminiu metalic	5TC8902
Carbon metalic	5TC8903