

## Overview



SIRIUS ACT pushbuttons and indicator lights

**SIRIUS ACT – commanding and signaling**

SIRIUS ACT is a modular system of pushbuttons and indicator lights for front plate mounting and rear-mounted electrical modules.

Extensive portfolio

- Customized variants, e.g. special tumbler arrangements, labeling, equipped enclosures
- Communication-enabled thanks to direct interfacing to AS-Interface, IO-Link or PROFINET

Diverse possible applications

- National and international approvals
- Many trade approvals
- Short delivery times thanks to global availability

Standards

- IEC 60947-1, EN 60947-1
- IEC 60947-5-1, EN 60947-5-1
- IEC 60947-5-5, EN 60947-5-5 for EMERGENCY STOP devices

**More information**

Home page, see [www.siemens.com/sirius-act](http://www.siemens.com/sirius-act)  
 Industry Mall, see [www.siemens.com/product?3SU1](http://www.siemens.com/product?3SU1)  
 Configurator, see [www.siemens.com/sirius-act/configurator](http://www.siemens.com/sirius-act/configurator)  
 Conversion tool, see [www.siemens.com/sirius/conversion-tool](http://www.siemens.com/sirius/conversion-tool)  
 Manual, see <https://support.industry.siemens.com/cs/ww/en/view/107542462>

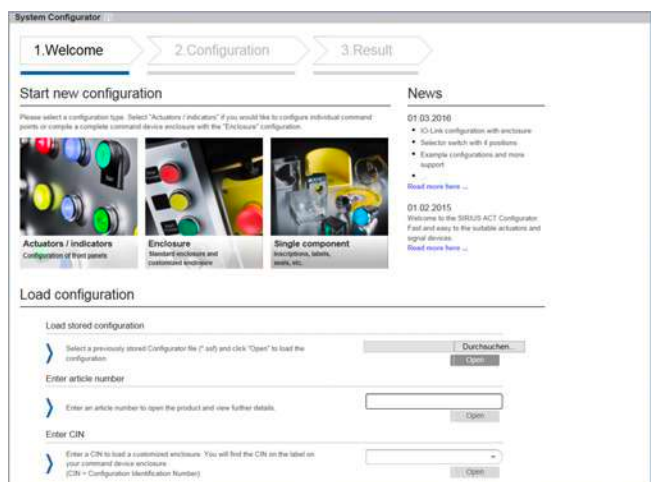
**Configurator**

- Fast, simple selection by intuitive navigation through clearly-organized menus using drag & drop
- Image preview of selected components
- Inscription of pushbuttons and labeling plates using the interactive inscription tool
- Once created, a configuration can be ordered as often as required using the customer-specific article number and the CIN (Configuration Identification Number)
- Everything at a glance: Product data sheets, certificates, dimensional drawings, list prices, inscription tool

# SIRIUS ACT Pushbuttons and Indicator Lights

## General data

### Benefits

#### Design

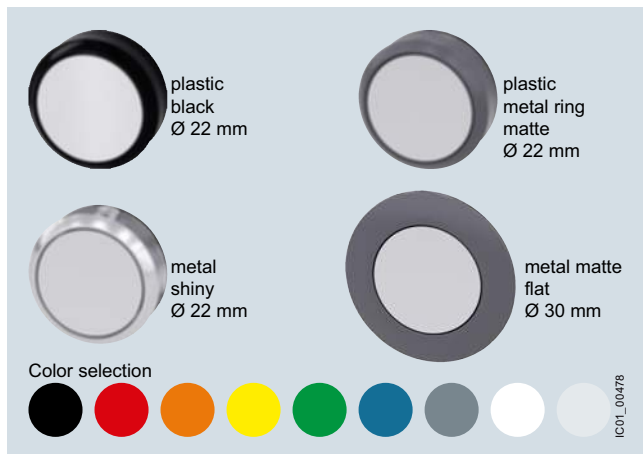

SIRIUS ACT is available in four design lines.

#### Ruggedness



- Degree of protection IP66, IP67, IP69 (IP69K)

#### IP66

6 = Protection against the ingress of dust

6 = Protection against powerful splashwater

#### IP67

6 = Protection against the ingress of dust

7 = Protection against temporary immersion

#### IP69 (IP69K)

6 = Protection against the ingress of dust

9/9K = Protection against water in high-pressure cleaning (approx. 80 bar) and high water jet temperatures (approx. 80°C)

- Service life of 100 000 hours thanks to use of LEDs
- Media resistance (chemicals) thanks to solid stainless steel and high-grade plastics
- Mechanical endurance of  $10 \times 10^6$  switching cycles
- Suitable for use in extreme environments
- Reliable, friction-locked fixing with just one screw
- Design stability according to use
- Simple geometry for mounting holes

#### Communication



- Direct connection of the enclosure to AS-Interface or IO-Link
- Direct connection in the control cabinet to PROFINET, IO-Link or AS-Interface
- Can be integrated easily via the TIA Portal

#### Easy handling

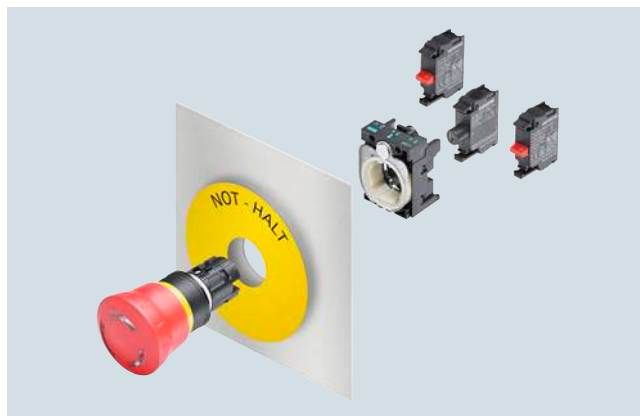

- Self-holding function of the actuator when mounting
- Twist prevention integrated into patented holder design
- Stackable contact modules
- Self-explanatory and fast installation using one hand
- Components can be mounted with holder removed
- No special tools required, simple size 2 screwdriver (cross-tip DIN ISO 87641PZD1, flat-head DIN ISO 2380-1 A/B 1x4.5) is sufficient

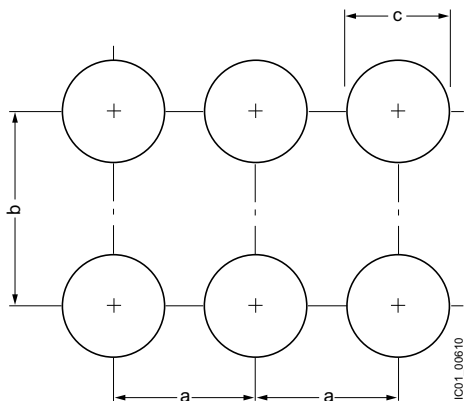
**Mounting dimensions****Versions**

SIRIUS ACT is a modular system of pushbuttons and indicator lights with which customized variants can be configured flexibly.

One command point comprises:

- An actuating or signaling element in front of the control panel
- A holder for securing behind the control panel
- Up to six contact modules and/or one LED module (mounted onto the holder), single-pole contacts can be stacked
- A comprehensive range of accessories for inscription/markings

**Complete units**

Complete units made up of an actuating or signaling element, holder and contact modules and/or LED modules are offered for the most frequent application cases. The electrical parts are integrated and only have to be wired.



- 1 Actuator
- 2 Holder
- 3 LED module
- 4 NO contact

	Minimum clearance		
	a	b	c
	mm	mm	mm
<b>22 mm plastic, plastic with metal front ring, metal for front plate thickness 1 ... 6 mm</b>			
3-slot holder	30	40	22.3 <sup>+0.4</sup>
4-slot holder	40	40	22.3 <sup>+0.4</sup>
<b>30 mm, metal, matte for front plate thickness 1 ... 4 mm</b>			
3-slot holder	40	45	30.5 <sup>+0.5</sup>

**Compact units**

Signaling devices, sensor switches, pushbuttons with extended stroke and potentiometers are available as compact units. The electronic circuitry is already integrated in these devices, i.e. it is not necessary to snap on a contact or LED module.

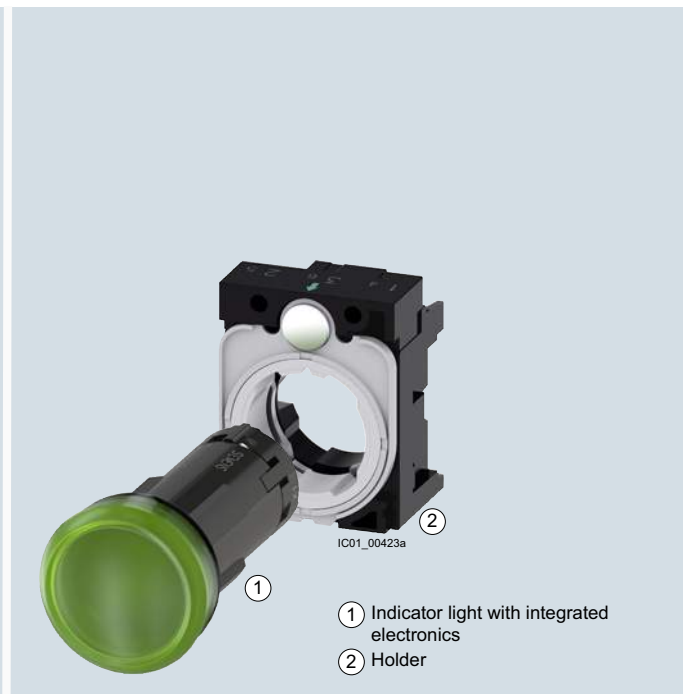

- 1 Indicator light with integrated electronics
- 2 Holder

Complete units	Pages	Compact units	Pages
Plastic, black	13/18	Plastic, black	13/25
Plastic with metal front ring, matte	13/39	Plastic with metal front ring, matte	13/46
Metal, shiny	13/59	Metal, shiny	13/64

# SIRIUS ACT Pushbuttons and Indicator Lights

## General data

### Actuating and signaling elements



Actuating and signaling elements		Pages	Modules for front plate mounting		Pages
①	Pushbuttons, illuminated pushbuttons	13/18	⑮	Contact modules	13/85
②	Mushroom pushbuttons	13/20	⑯	LED modules	13/87
③	Selector switches	13/42	⑰	AS-Interface modules	13/89
④⑤ ⑥⑦	Key-operated switches, coordinate switches, potentiometers, indicator lights	13/43	<b>Enclosures</b>		<b>Pages</b>
⑧⑨	EMERGENCY STOP mushroom pushbuttons, backing plates	13/20	⑱	Enclosures	13/91
⑩⑪	ID key-operated switches with ID key, electronic modules	13/37	<b>Modules for base mounting</b>		<b>Pages</b>
⑫	Twin pushbuttons, label holders, labeling plates	13/29	⑲	Contact modules	13/99
<b>Holders and labels</b>		<b>Pages</b>	⑳	LED modules	13/99
⑬	Label holders, labeling plates	13/104	㉑	IO-Link modules	13/102
⑭	Holder	13/104	㉒	AS-Interface modules	13/102







System overview of SIRIUS ACT pushbuttons and indicator lights from the plastic design line. Pushbuttons and indicator lights available in 4 design lines.

# SIRIUS ACT Pushbuttons and Indicator Lights

Actuators and Indicators, 22 mm, Metal, Shiny  
Complete Units

## Indicator lights

### Selection and ordering data

Indicator lights	Operational voltage		Color		SD	Screw terminals	PU (UNIT, SET, M)	PS*	PG			
	At AC, rated value	At DC, rated value	of actuating element	of light source								
	V	V			d	Article No.	Price per PU					
 3SU1152-6AA50-1AA0	24	24	Amber	Amber	5	<b>3SU1152-6AA00-1AA0</b>	1	1 unit	41J			
			Red	Red	▶	<b>3SU1152-6AA20-1AA0</b>	1	1 unit	41J			
			Yellow	Yellow	▶	<b>3SU1152-6AA30-1AA0</b>	1	1 unit	41J			
			Green	Green	▶	<b>3SU1152-6AA40-1AA0</b>	1	1 unit	41J			
			Blue	Blue	3	<b>3SU1152-6AA50-1AA0</b>	1	1 unit	41J			
			White	White	▶	<b>3SU1152-6AA60-1AA0</b>	1	1 unit	41J			
			Clear	White	3	<b>3SU1152-6AA70-1AA0</b>	1	1 unit	41J			
 3SU1153-6AA00-1AA0	110	--	Amber	Amber	5	<b>3SU1153-6AA00-1AA0</b>	1	1 unit	41J			
			Red	Red	▶	<b>3SU1153-6AA20-1AA0</b>	1	1 unit	41J			
			Yellow	Yellow	3	<b>3SU1153-6AA30-1AA0</b>	1	1 unit	41J			
			Green	Green	▶	<b>3SU1153-6AA40-1AA0</b>	1	1 unit	41J			
			Blue	Blue	5	<b>3SU1153-6AA50-1AA0</b>	1	1 unit	41J			
			White	White	3	<b>3SU1153-6AA60-1AA0</b>	1	1 unit	41J			
			Clear	White	5	<b>3SU1153-6AA70-1AA0</b>	1	1 unit	41J			
 3SU1156-6AA60-1AA0	230	--	Red	Red	▶	<b>3SU1156-6AA20-1AA0</b>	1	1 unit	41J			
			Yellow	Yellow	3	<b>3SU1156-6AA30-1AA0</b>	1	1 unit	41J			
			Green	Green	▶	<b>3SU1156-6AA40-1AA0</b>	1	1 unit	41J			
			Blue	Blue	5	<b>3SU1156-6AA50-1AA0</b>	1	1 unit	41J			
			White	White	3	<b>3SU1156-6AA60-1AA0</b>	1	1 unit	41J			
			Clear	White	5	<b>3SU1156-6AA70-1AA0</b>	1	1 unit	41J			
			 3SU1152-6AA40-3AA0	24	24	Red	Red	3	<b>3SU1152-6AA20-3AA0</b>	1	1 unit	41J
Yellow	Yellow	5				<b>3SU1152-6AA30-3AA0</b>	1	1 unit	41J			
Green	Green	3				<b>3SU1152-6AA40-3AA0</b>	1	1 unit	41J			
Blue	Blue	3				<b>3SU1152-6AA50-3AA0</b>	1	1 unit	41J			
White	White	5				<b>3SU1152-6AA60-3AA0</b>	1	1 unit	41J			
Clear	White	5				<b>3SU1152-6AA70-3AA0</b>	1	1 unit	41J			
 3SU1153-6AA30-3AA0	110	--				Red	Red	5	<b>3SU1153-6AA20-3AA0</b>	1	1 unit	41J
						Yellow	Yellow	5	<b>3SU1153-6AA30-3AA0</b>	1	1 unit	41J
						Green	Green	5	<b>3SU1153-6AA40-3AA0</b>	1	1 unit	41J
						Blue	Blue	5	<b>3SU1153-6AA50-3AA0</b>	1	1 unit	41J
						White	White	5	<b>3SU1153-6AA60-3AA0</b>	1	1 unit	41J
						Clear	White	5	<b>3SU1153-6AA70-3AA0</b>	1	1 unit	41J
						 3SU1156-6AA20-3AA0	230	--	Red	Red	5	<b>3SU1156-6AA20-3AA0</b>
Yellow	Yellow	5							<b>3SU1156-6AA30-3AA0</b>	1	1 unit	41J
Green	Green	5	<b>3SU1156-6AA40-3AA0</b>	1	1 unit				41J			
Blue	Blue	5	<b>3SU1156-6AA50-3AA0</b>	1	1 unit				41J			
White	White	5	<b>3SU1156-6AA60-3AA0</b>	1	1 unit				41J			
Clear	White	5	<b>3SU1156-6AA70-3AA0</b>	1	1 unit				41J			