

Overview



SIRIUS ACT pushbuttons and indicator lights

SIRIUS ACT – commanding and signaling

SIRIUS ACT is a modular system of pushbuttons and indicator lights for front plate mounting and rear-mounted electrical modules.

Extensive portfolio

- Customized variants, e.g. special tumbler arrangements, labeling, equipped enclosures
- Communication-enabled thanks to direct interfacing to AS-Interface, IO-Link or PROFINET

Diverse possible applications

- National and international approvals
- Many trade approvals
- Short delivery times thanks to global availability

Standards

- IEC 60947-1, EN 60947-1
- IEC 60947-5-1, EN 60947-5-1
- IEC 60947-5-5, EN 60947-5-5 for EMERGENCY STOP devices

More information

Home page, see www.siemens.com/sirius-act
 Industry Mall, see www.siemens.com/product?3SU1
 Configurator, see www.siemens.com/sirius-act/configurator
 Conversion tool, see www.siemens.com/sirius/conversion-tool
 Manual, see <https://support.industry.siemens.com/cs/ww/en/view/107542462>

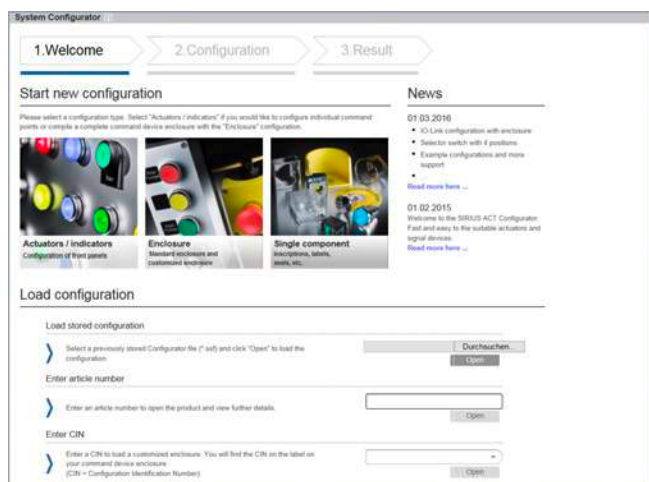
Configurator

- Fast, simple selection by intuitive navigation through clearly-organized menus using drag & drop
- Image preview of selected components
- Inscription of pushbuttons and labeling plates using the interactive inscription tool
- Once created, a configuration can be ordered as often as required using the customer-specific article number and the CIN (Configuration Identification Number)
- Everything at a glance: Product data sheets, certificates, dimensional drawings, list prices, inscription tool

SIRIUS ACT Pushbuttons and Indicator Lights

General data

Benefits

Design

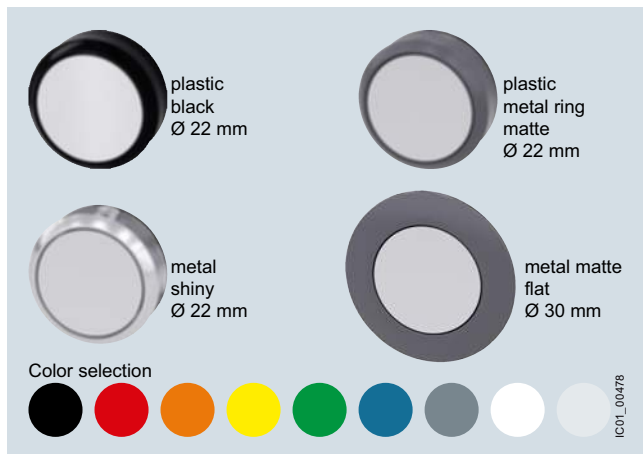

SIRIUS ACT is available in four design lines.

Ruggedness



- Degree of protection IP66, IP67, IP69 (IP69K)

IP66

6 = Protection against the ingress of dust

6 = Protection against powerful splashwater

IP67

6 = Protection against the ingress of dust

7 = Protection against temporary immersion

IP69 (IP69K)

6 = Protection against the ingress of dust

9/9K = Protection against water in high-pressure cleaning (approx. 80 bar) and high water jet temperatures (approx. 80°C)

- Service life of 100 000 hours thanks to use of LEDs
- Media resistance (chemicals) thanks to solid stainless steel and high-grade plastics
- Mechanical endurance of 10×10^6 switching cycles
- Suitable for use in extreme environments
- Reliable, friction-locked fixing with just one screw
- Design stability according to use
- Simple geometry for mounting holes

Communication



- Direct connection of the enclosure to AS-Interface or IO-Link
- Direct connection in the control cabinet to PROFINET, IO-Link or AS-Interface
- Can be integrated easily via the TIA Portal

Easy handling

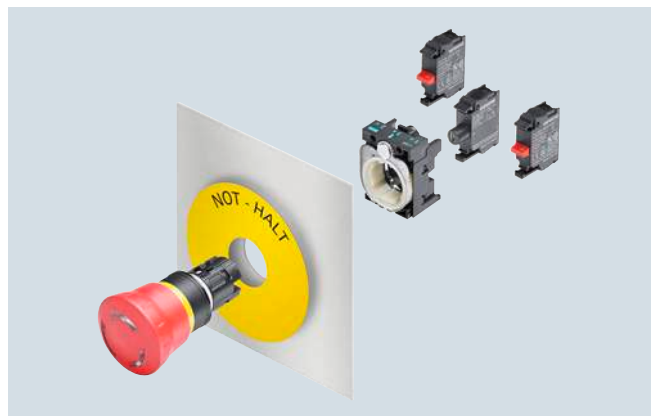

- Self-holding function of the actuator when mounting
- Twist prevention integrated into patented holder design
- Stackable contact modules
- Self-explanatory and fast installation using one hand
- Components can be mounted with holder removed
- No special tools required, simple size 2 screwdriver (cross-tip DIN ISO 87641PZD1, flat-head DIN ISO 2380-1 A/B 1x4.5) is sufficient

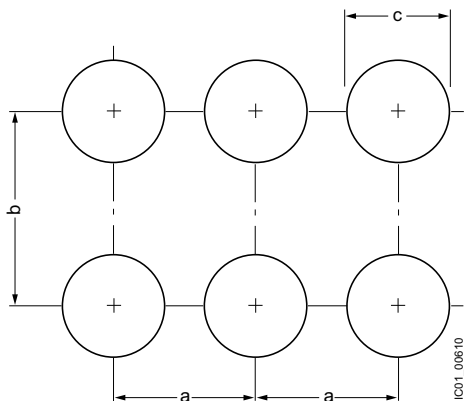
Mounting dimensions**Versions**

SIRIUS ACT is a modular system of pushbuttons and indicator lights with which customized variants can be configured flexibly.

One command point comprises:

- An actuating or signaling element in front of the control panel
- A holder for securing behind the control panel
- Up to six contact modules and/or one LED module (mounted onto the holder), single-pole contacts can be stacked
- A comprehensive range of accessories for inscription/markings

Complete units

Complete units made up of an actuating or signaling element, holder and contact modules and/or LED modules are offered for the most frequent application cases. The electrical parts are integrated and only have to be wired.



- 1 Actuator
- 2 Holder
- 3 LED module
- 4 NO contact

	Minimum clearance		
	a	b	c
	mm	mm	mm
22 mm plastic, plastic with metal front ring, metal for front plate thickness 1 ... 6 mm			
3-slot holder	30	40	22.3 ^{+0.4}
4-slot holder	40	40	22.3 ^{+0.4}
30 mm, metal, matte for front plate thickness 1 ... 4 mm			
3-slot holder	40	45	30.5 ^{+0.5}

Compact units

Signaling devices, sensor switches, pushbuttons with extended stroke and potentiometers are available as compact units. The electronic circuitry is already integrated in these devices, i.e. it is not necessary to snap on a contact or LED module.

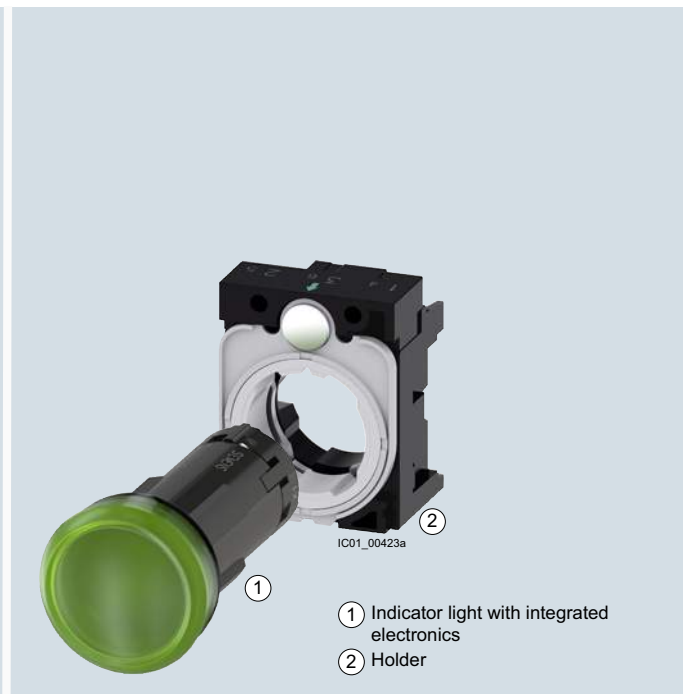

- 1 Indicator light with integrated electronics
- 2 Holder

Complete units	Pages	Compact units	Pages
Plastic, black	13/18	Plastic, black	13/25
Plastic with metal front ring, matte	13/39	Plastic with metal front ring, matte	13/46
Metal, shiny	13/59	Metal, shiny	13/64

SIRIUS ACT Pushbuttons and Indicator Lights

General data

Actuating and signaling elements

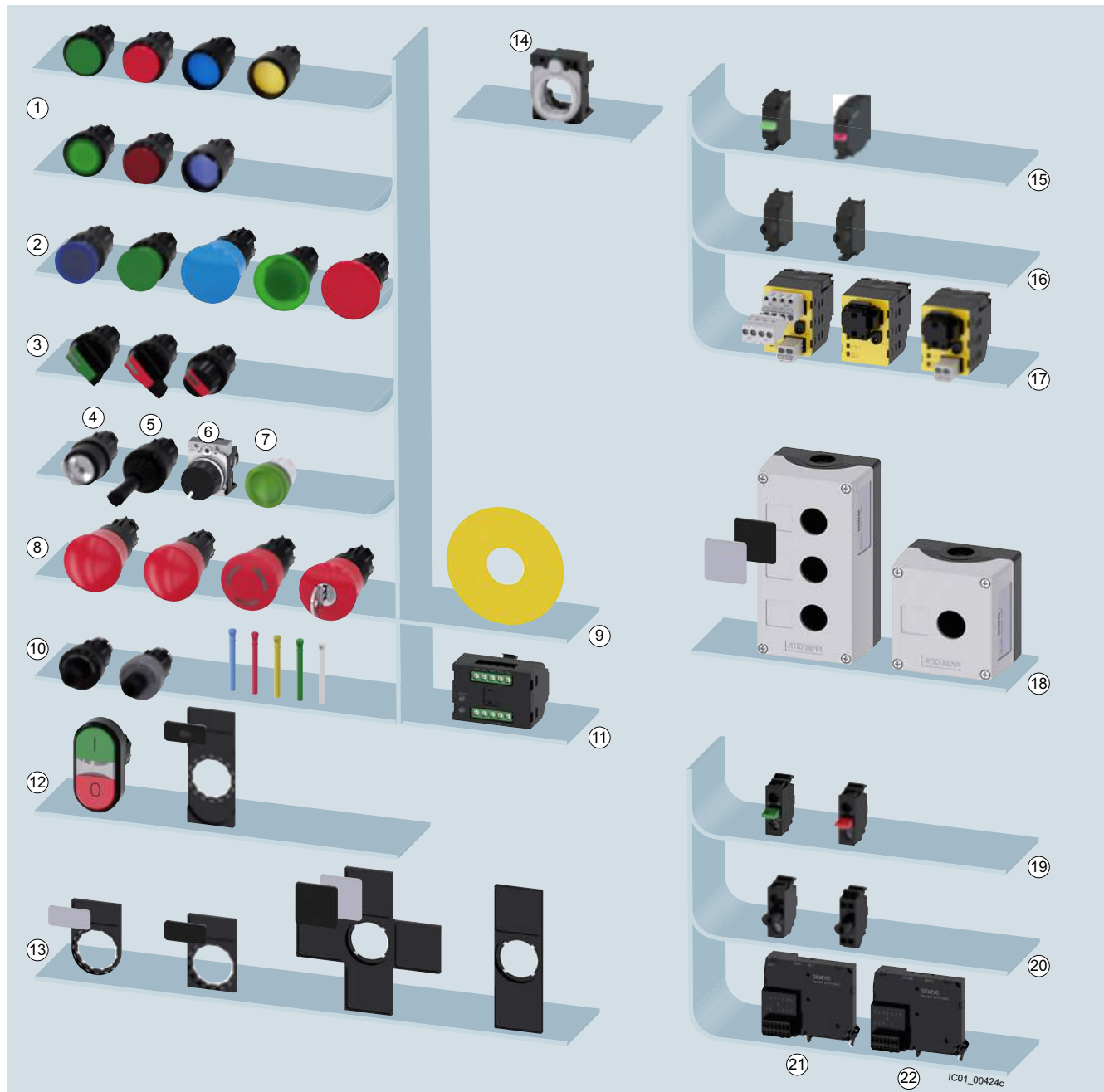

Actuating and signaling elements		Pages	Modules for front plate mounting		Pages
①	Pushbuttons, illuminated pushbuttons	13/18	⑮	Contact modules	13/85
②	Mushroom pushbuttons	13/20	⑯	LED modules	13/87
③	Selector switches	13/42	⑰	AS-Interface modules	13/89
④⑤ ⑥⑦	Key-operated switches, coordinate switches, potentiometers, indicator lights	13/43	Enclosures		Pages
⑧⑨	EMERGENCY STOP mushroom pushbuttons, backing plates	13/20	⑱	Enclosures	13/91
⑩⑪	ID key-operated switches with ID key, electronic modules	13/37	Modules for base mounting		Pages
⑫	Twin pushbuttons, label holders, labeling plates	13/29	⑲	Contact modules	13/99
Holders and labels		Pages	⑳	LED modules	13/99
⑬	Label holders, labeling plates	13/104	㉑	IO-Link modules	13/102
⑭	Holder	13/104	㉒	AS-Interface modules	13/102

System overview of SIRIUS ACT pushbuttons and indicator lights from the plastic design line. Pushbuttons and indicator lights available in 4 design lines.

SIRIUS ACT Pushbuttons and Indicator Lights

Actuators and Indicators, 22 mm, Round, Plastic, Black Complete Units



Selector switches

Selection and ordering data

Operating principle	Color	Number of			SD	Screw terminals 	PU (UNIT, SET, M)	PS*	PG
		Supply voltage for light source	Contact modules	NO contacts					
						Article No.	Price per PU		

Selector switches

Short black actuator, 2 switch positions, can be illuminated



 3SU1100-2BF60-1BA0 	Latching, 90°	White	1	1	0	▶	3SU1100-2BF60-1BA0	1	1 unit	41J
			2	1	1	▶	3SU1100-2BF60-1MA0	1	1 unit	41J
		White 110 V	1	1	0	5	3SU1103-2BF60-1BA0	1	1 unit	41J

Short black actuator, 3 switch positions, can be illuminated



 3SU1100-2BM60-1NA0 	Momentary contact, 2x45°, reset from right + left	White	2	2	0	▶	3SU1100-2BM60-1NA0	1	1 unit	41J
---	---	-------	---	---	---	---	---------------------------	---	--------	-----



 3SU1100-2BL60-1NA0 	Latching, 2x45°	White	2	2	0	▶	3SU1100-2BL60-1NA0	1	1 unit	41J
--	-----------------	-------	---	---	---	---	---------------------------	---	--------	-----

Short black actuator, 2 switch positions, can be illuminated

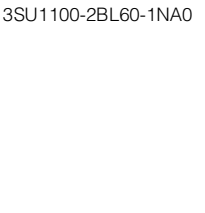
						Spring-type terminals 				
 3SU1100-2BF60-3BA0 	Latching, 90°	White	1	1	0	5	3SU1100-2BF60-3BA0	1	1 unit	41J
			2	1	1	5	3SU1100-2BF60-3MA0	1	1 unit	41J

Short black actuator, 3 switch positions, can be illuminated

 3SU1100-2BM60-3NA0 	Momentary contact, 2x45°, reset from right + left	White	2	2	0	5	3SU1100-2BM60-3NA0	1	1 unit	41J
--	---	-------	---	---	---	---	---------------------------	---	--------	-----

 3SU1100-2BL60-3NA0 	Latching, 2x45°	White	2	2	0	5	3SU1100-2BL60-3NA0	1	1 unit	41J
--	-----------------	-------	---	---	---	---	---------------------------	---	--------	-----