

Surge arrester ETITEC group B EN/IEC/VDE: T1, T2, T3 / I, II, III / B+C+D

Description

ETITEC B is surge arrester for indoor application. Group B overvoltage protection is in accordance with VDE class B, C, D. This protection corresponds to IEC category I, II, III and EN Type 1, Type 2, Type 3. The protection is made on the main distribution box, as the first level of protection against lightning strikes, partial direct, indirect atmospheric discharges and induced surges. In case of permanent arrester damage, thermal protection is activated which signalizes faulty arrester. Consequently only the SPD module has to be replaced, while base unit remains fixed on DIN rail.

*Note: First number of designation 1+0, 2+0, 3+1 etc. indicates the number of varistors. Second one means the following: number 0 indicates there is no gas discharge tube, number 1 indicates there is.

Advantages:

- remote signalisation (RC version only)
- DIN rail mounting (EN 60715)
- high discharge currents
- high degree of protection
- varistor is the protective element
- metal snapper, new way of mounting on DINrail (easier, quicker)
- modular design
- IEC/EN 61643-11
- RoHS compliant
- connection up to 35mm²

New!

 ETITEC B T12 I_{imp} =12,5kA

Type	Code No.	I _{imp} (10/350) [kA]	I _n /I _{max} (8/20) [kA]	U _c [V AC]	Weight [g]	Packaging [pcs]
ETITEC B T12 150/12,5 1+0	002440311	12,5	25/60	150	124	1/12
ETITEC B T12 150/12,5 1+0 RC	002440312	12,5	25/60	150	129	1/12
ETITEC B T12 275/12,5 1+0	002440313	12,5	25/60	275	150	1/12
ETITEC B T12 275/12,5 1+0 RC	002440314	12,5	25/60	275	155	1/12
ETITEC B T12 440/12,5 1+0	002440315	12,5	25/60	440	150	1/12
ETITEC B T12 440/12,5 1+0 RC	002440316	12,5	25/60	440	155	1/12
ETITEC B T12 275/12,5 2+0	002440317	12,5	25/60	275	198	1/7
ETITEC B T12 275/12,5 2+0 RC	002440318	12,5	25/60	275	203	1/7
ETITEC B T12 440/12,5 2+0	002440319	12,5	25/60	440	251	1/7
ETITEC B T12 440/12,5 2+0 RC	002440320	12,5	25/60	440	256	1/7
ETITEC B T12 275/12,5 3+0	002440321	12,5	25/60	275	382	1/5
ETITEC B T12 275/12,5 3+0 RC	002440322	12,5	25/60	275	387	1/5
ETITEC B T12 440/12,5 3+0	002440323	12,5	25/60	440	382	1/5
ETITEC B T12 440/12,5 3+0 RC	002440324	12,5	25/60	440	387	1/5
ETITEC B T12 275/12,5 4+0	002440325	12,5	25/60	275	462	1/3
ETITEC B T12 275/12,5 4+0 RC	002440326	12,5	25/60	275	467	1/3
ETITEC B T12 440/12,5 4+0	002440327	12,5	25/60	440	462	1/3
ETITEC B T12 440/12,5 4+0 RC	002440328	12,5	25/60	440	467	1/3
ETITEC B T12 275/12,5 1+1	002440329	12,5	25/60	275	198	1/7
ETITEC B T12 275/12,5 1+1 RC	002440330	12,5	25/60	275	203	1/7
ETITEC B T12 275/12,5 3+1	002440331	12,5	25/60	275	462	1/3
ETITEC B T12 275/12,5 3+1 RC	002440332	12,5	25/60	275	467	1/3
MOD.ETITEC B T12 150/12,5	002440333	12,5	25/60	150	78	12
MOD.ETITEC B T12 275/12,5	002440334	12,5	25/60	275	88	12
MOD.ETITEC B T12 440/12,5	002440335	12,5	25/60	440	102	12
MOD.ETITEC B T12 255/50	002440310	12,5	25/60	255	70	12

* RC -> remote signalisation. Note: I_{imp} and I_n/I_{max} - defined per single pole



ETITEC B T12 275/12,5 1+0



ETITEC B T12 275/12,5 4+0

Technical data

ETITECT WENT $I_{imp}=12,5 \text{ kA}$

TN-S Network - Single-phase, 1+0 (T-connection)

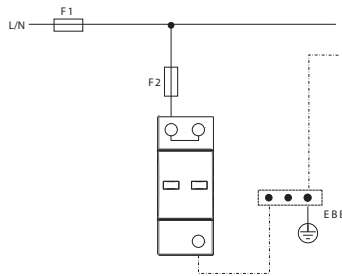

TN-C Network - Single-phase, 1+0 (T-connection)

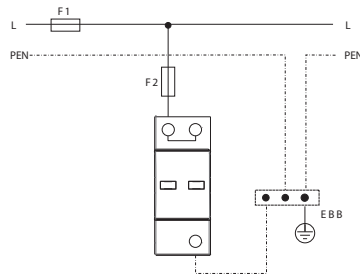

TN-S Network - Single-phase, 2+0 (T-connection)

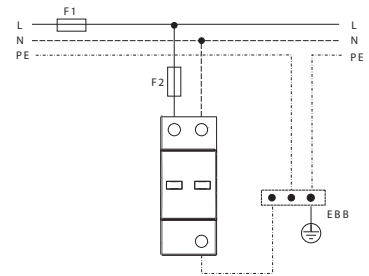

TN-S Network - Three-phase, 4+0 (T-connection)

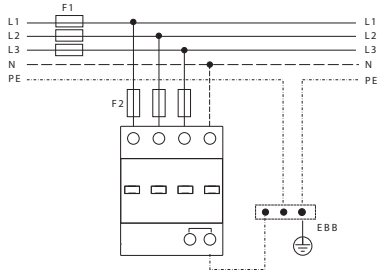

TN-C Network - Three-phase 3+0 (T-connection)

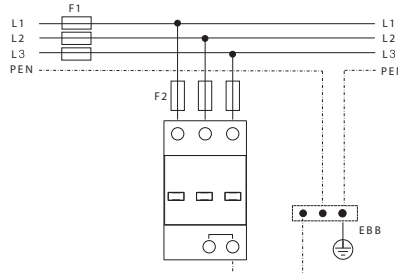

TT Network - Single-phase 1+1 (T-connection)

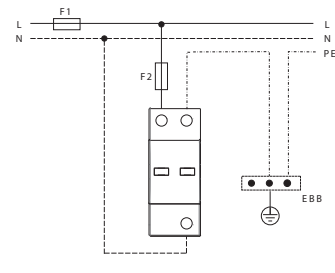

TT Network - Three-phase 3+1 (T-connection)

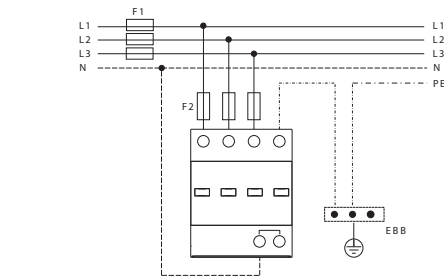

Remote signalization connection / Back-up fuse

Back-up fuse	
$F1 > 250 \text{ A gG}$	$\rightarrow F2 = 250 \text{ A gG}$
$F1 \leq 250 \text{ A gG}$	$\rightarrow F2 = \text{not needed}$

A.C.	250V / 0.5A
D.C.	250V / 0.1A
	125V / 0.2A
	75V / 0.5A

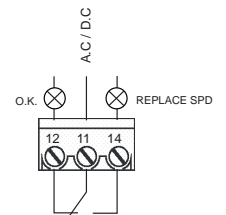

Dimensions

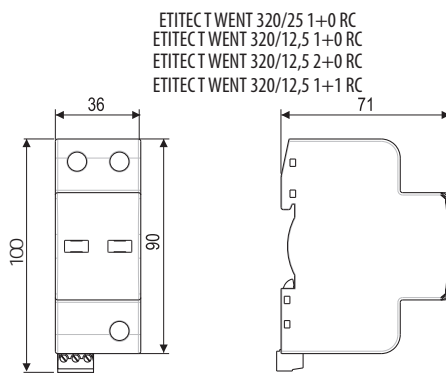

ETITECT WENT 320/12,5 3+0 RC

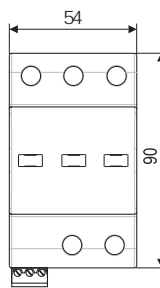

ETITECT WENT 320/12,5 4+0 RC
ETITECT WENT 320/12,5 3+1 RC

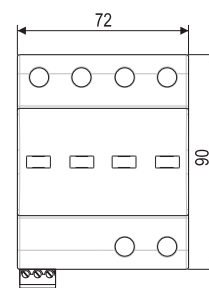

ETITECT WENT 320/25 2+0 RC
ETITECT WENT 320/25 1+1 RC

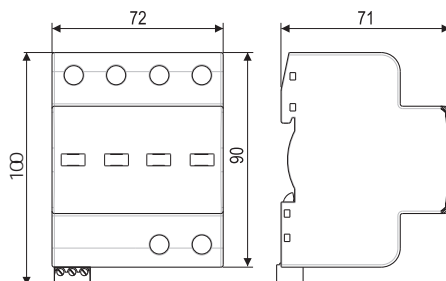

ETITECT WENT 320/25 3+0 RC

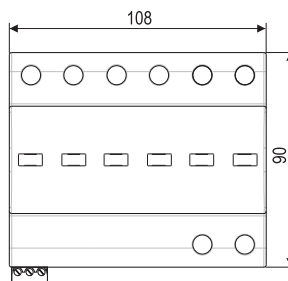

ETITECT WENT 320/25 4+0 RC
ETITECT WENT 320/25 3+1 RC

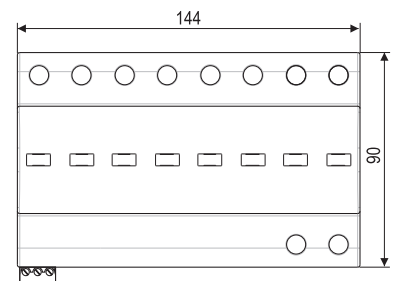

Connection diagram

ETITECT WENT limp=12,5 kA

ETITECT WENT 320/12,5 1+0

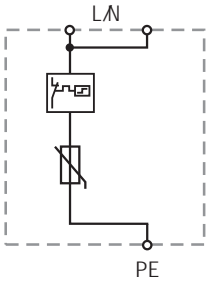

ETITECT WENT 320/12,5 1+0 RC

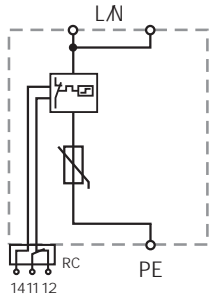

ETITECT WENT 320/12,5 1+1

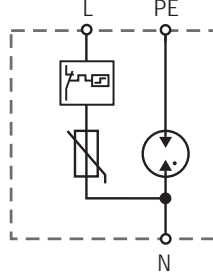

ETITECT WENT 320/12,5 1+1 RC

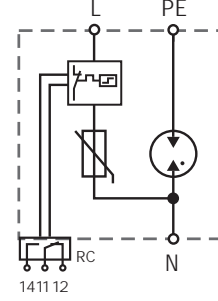

ETITECT WENT 320/12,5 2+0

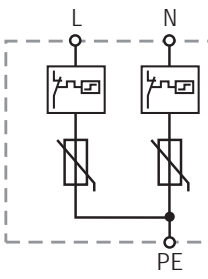

ETITECT WENT 320/12,5 2+0 RC

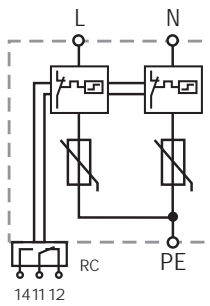

ETITECT WENT 320/12,5 3+0

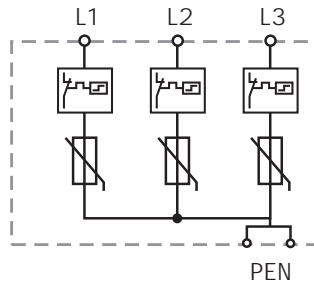

ETITECT WENT 320/12,5 3+0 RC

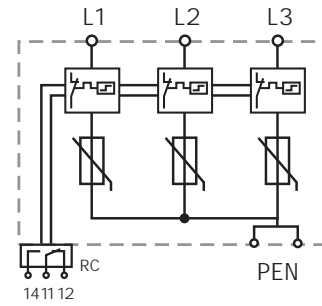

ETITECT WENT 320/12,5 3+1

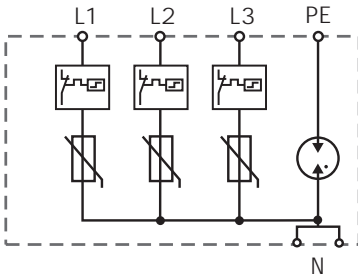

ETITECT WENT 320/12,5 3+1 RC

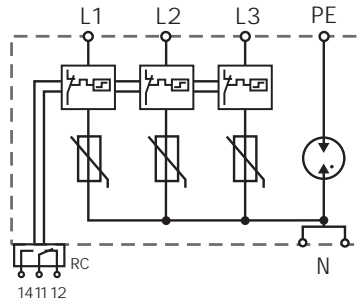

ETITECT WENT 320/12,5 4+0

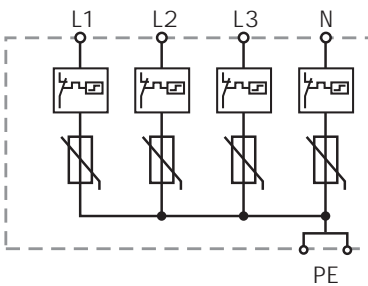

ETITECT WENT 320/12,5 4+0 RC

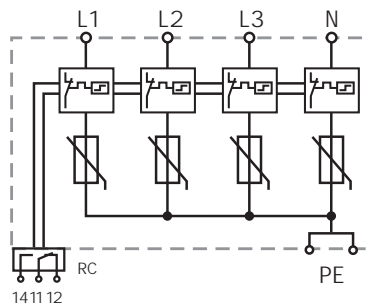

Surge arrester ETITEC group B EN/IEC/VDE: T1, T2, T3 / I, II, III / B+C+D

ETITEC B T12 Iimp=12,5kA			
Type	150/12,5	275/12,5	440/12,5
In accordance with	IEC/EN 61643-11		
Category IEC/EN/VDE	I, II, III / T1, T2, T3 / B, C, D		
Max. continuous operating voltage (AC) Uc	150 V	275 V	440 V
Nominal discharge current (8/20) In	25 kA		
Max. discharge current (8/20) I _{max}	60 kA		
Impulse current (10/350) I _{imp}	12,5 kA		
Nominal AC voltage U _o	230V 50-60 Hz		
TOV immunity U _r (AC)	334 V/5s withstand 438 V/120 min safe disconnection		
Charge			
Protection level U _p - at I _n (8/20)	<1,0 kV	<1,4 kV	<2,0 kV
Follow current I _n	x		
Response time t _a	< 25 ns		
Residual current I _{pe} at U _{ref}	< 0,3 mA		
Thermal decoupler	✓		
Torque	3,0 Nm		
Back-up fuse (if mains > 160A)	160 A gG		
Short-circuit current rating I _{scCR}	25 kA / 50 Hz		
Temperature range	- 40°C ... +70°C		
Cross-section of connection wire	min. 4mm ² , max. single strand 35mm ² , multi-strand 25mm ²		
Mounting	indoors on top hat fixing rail 35 mm (EN 60715)		
Degree of protection	IP 20		
Casing material	thermoplastic; extinguishing degree UL 94 V-0		
Dimensions	1 TE ... 4 TE		
Indication of disconnector operation	red flag		
Permissible humidity	5% - 95%		
Additional data for ETITEC B-RC			
Remote signalisation (RC)	✓		
Switching capability (RC)	AC: 250V/0.5A; 125V/3A		
Cross-section of connection wire (RC)	max. 1.5 mm ²		
Torque (RC)	0,25 Nm		

Type of network and nr. of SPD poles	
Network	Nr of poles (SPD configuration)
TNC 1 phase	1+0
TNC 3 phase	3+0
TNS 1 phase	2+0 / 1+1
TNS 3 phase	4+0 / 3+1
TT 1 phase	1+1
TT 3 phase	3+1
IT 1 phase	2+0
IT 3 phase	4+0

At TNC, TNS, TT systems with U_n=230V, recommended U_c value of SPD is 275V. At IT system, recommended U_c value of SPD is 440V.

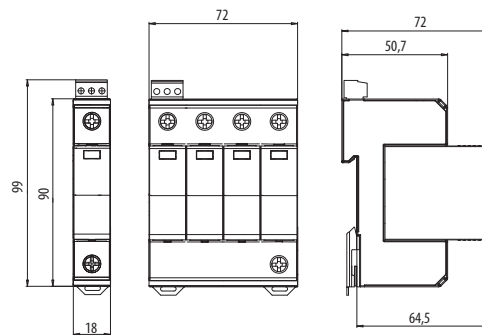

Type of network and nr. of SPD poles

Network	Nr of poles (SPD configuration)
TNC 1 phase	1+0
TNC 3 phase	3+0
TNS 1 phase	2+0 / 1+1
TNS 3 phase	4+0 / 3+1
TT 1 phase	1+1
TT 3 phase	3+1
IT 1 phase	2+0
IT 3 phase	4+0

At TNC, TNS, TT systems with $U_n=230V$, recommended U_c value of SPD is 275V.
 At IT system, recommended U_c value of SPD is 440V.

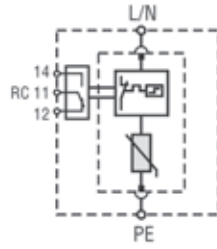

ETITEC B T12 275/7 1+0 RC

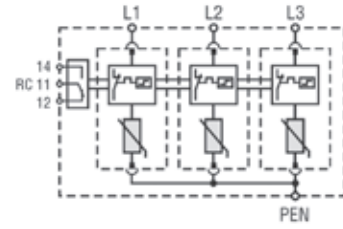

ETITEC B T12 275/7 3+0 RC

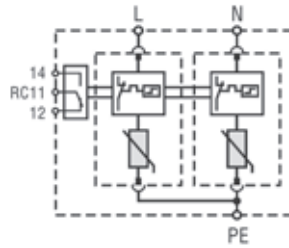

ETITEC B T12 275/7 2+0 RC

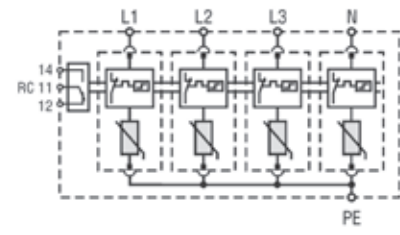

ETITEC B T12 275/7 4+0 RC

ETITEC B T12 275/7 4+0 RC

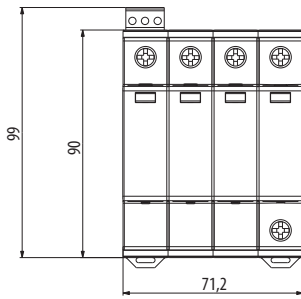

ETITEC B T12 275/7 3+0 RC

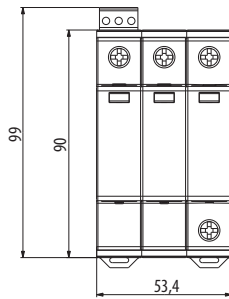

ETITEC B T12 275/7 2+0 RC

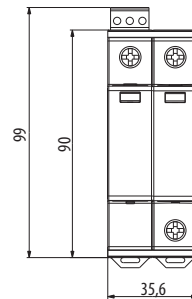

ETITEC B T12 275/7 1+0 RC

