

INDUSTRIAL INSTALLATIONS

High-quality protection of installations and devices in industry is ensured by wide selection of fuse-links and circuit breakers. Particularly important is the wide range of NV/NH fuse-links and switchgear combinations, i.e. fuse blocks and switch disconnectors. We also offer MCB's and power circuit breakers ETIBREAK. And not to forget ETICON contactors, plug-in outfit and line-up terminals SPOJ and overvoltage protection devices ETITEC. As well we can not provide solutions without switch disconnectors ETISWITCH and actuators and indicators ETISIG. The products are internationally certified and carry several quality marks.

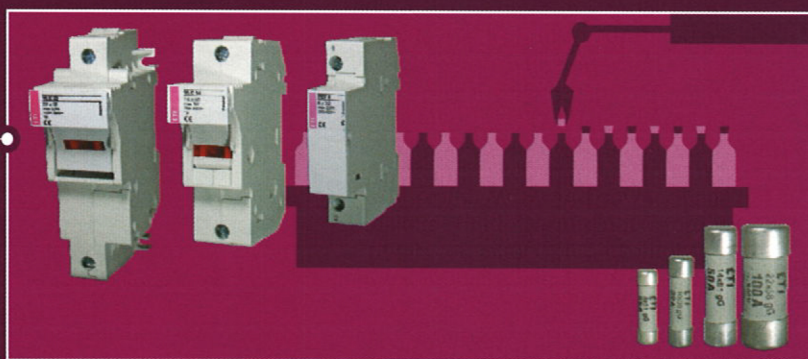

INDUSTRY

Switch-disconnector-fuse STVD02

Rated current
63 A

Utilization category
AC22

Switch-disconnector-fuse is a device which combines the functions of the switch and of the fuse D0.

The system enables the following advantages of protection in comparison with the fuse D0:

- The changing of the fuse-link without danger of direct touch of parts under voltage.
- Snap-on mounting on rail according to EN 60715.
- The complete protection against touch according to VBG 4.
- The possibility of connecting supply from the upper or from the lower side.
- It can be used as a main switch and tariff fuse in a single device.
- Possibility of sealing in ON or OFF positions with or without fuse-link.



STVD02

Type	I _n [A]	Code No.	Weight [g]	Packaging [pcs]
STV D02-1	63	002271001	119	12/96
STV D02-1N	63	002271002	238	6/48
STV D02-2	63	002271003	238	6/48
STV D02-3	63	002271004	357	4/32
STV D02-3N	63	002271005	476	3/24

D0

Accessories for switch - disconnector - fuse STVD02



Auxiliary switch PS STV

Type	Code No.	Contacts	Weight [g]
PS STV - MD	002279001	1 x b, 1 x a	50
PS STV - 2M	002279002	2 x b	50
PS STV - 2D	002279003	2 x a	50

a... make contact
b... breake contact

Auxiliary switch PS STV is intended to be mounted with switches of series STV D02. The width of apparatus is 9 mm, other dimensions comply with STV D02 series switches.

Auxiliary switch PS STV D02 serves for distant signalization of the state of contacts (on/off) of STV D02 switch, or for circuit control.

Protection cover

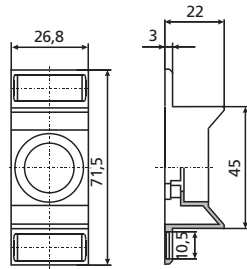

D01, D02

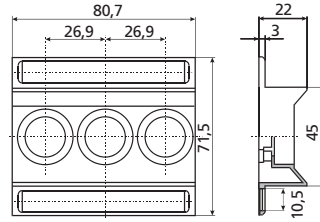

D01/3, D02/3

Gauge piece

V D01 for fuse base E 14		
I_n [A]	dimension	
	$\varnothing A$	$\varnothing B$
2	7,9	12
4	7,9	12
6	7,9	12
10	9,1	12

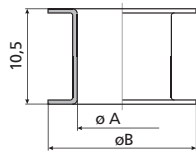

V D02 for fuse base E 18		
I_n [A]	dimension	
	$\varnothing A$	$\varnothing B$
2*	7,9	16,6
4*	7,9	16,6
6*	7,9	16,6
10*	9,1	16,6
16*	10,3	16,6
20	11,5	16,6
25	12,7	16,6
35	13,9	16,6
50	15,1	16,6

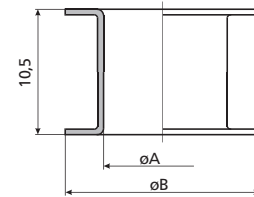

*For using fuse-links D01 and fuse bases D02.

Fuse carrier D0

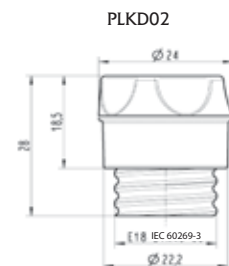
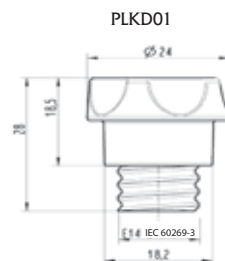
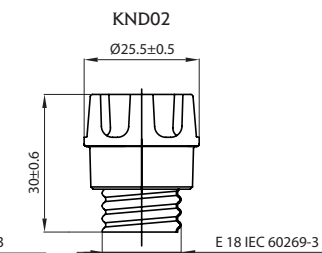
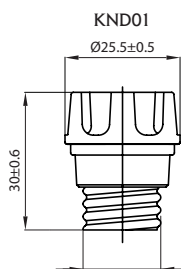

Technical data

Fuse - switch disconnecter VLD01

Technical data:

Rated voltage U_n	230 V, 230/400 V, 400 V a.c.
Rated current I_n	2-6 A, 10 A, 13 A, 16 A
Rated frequency f_n	45-62 Hz
Utilization category	AC-22 A
Mechanical life	10.000 cycles
Electrical life	1500 cycles
Poles	1p, 1p+N, 2p, 3p, 3p+N
Standards	IEC/EN 60947-1 IEC/EN 60947-3 DIN EN 60947-1 VDE 0660-100 DIN EN 60947-3 VDE 0660-107 IEC 60269-1 Ed. 4.1 2009-07 IEC 60269-3 Ed. 4.0 2010-05
Terminal capacity	1,5 -25mm ²

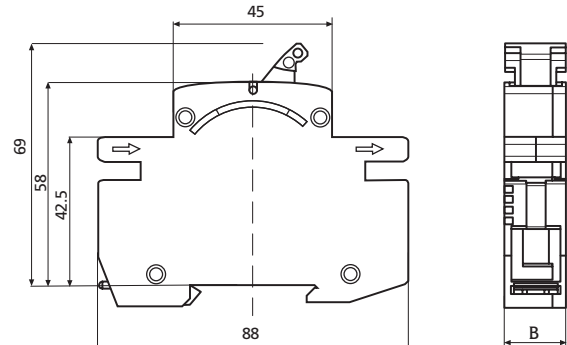

type	B [mm]
1p	17,5
1p+N	35
2p	35
3p	52,5
3p+N	70

Switch - disconnecter - fuse STVD02

Technical data

Number of poles	1p, 1p+N, 2p, 3p, 3p+N
Rated voltage	230/400 V a.c., 110 V (2p) d.c.
Rated current	63 A
Rated breaking capacity	50 kA
Rated insulation voltage	400 V
Rated impulse resistance voltage	6000 V
Category of use according to DIN VDE 0638	AC 22(63 A), AC 23(35 A), DC 22 (63 A)
Category of use according to DIN E 60 947-3	AC-22A (63A/400V AC), AC-23A (35A/400V AC), DC-22B (63A/110V DC)
Mechanical life	8.500 cycles
Electrical life	1.500 cycles
Temperature of environment	-5°C ... +40°C
Air humidity	90%
Degree of protection	IP 00 according to DIN 40 050
Standards	IEC/EN 60947-1 IEC/EN 60947-3 DIN EN 60947-1 VDE 0660-100 DIN EN 60947-3 VDE 0660-107 IEC 60269-1 Ed. 4.1 2009-07 IEC 60269-3 Ed. 4.0 2010-05
Terminal capacity	1,5 - 35mm ²
Possibility of sealing	in ON or OFF position

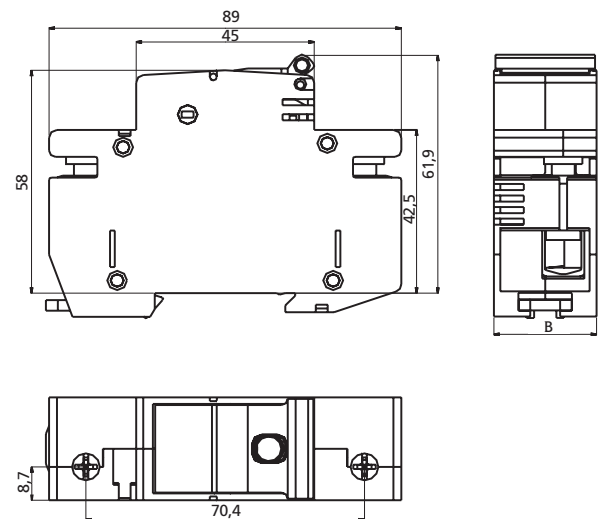

type	B [mm]
1p	26,8
1p+N	53,6
2p	53,6
3p	80,4
3p+N	107,2