

INDUSTRIAL INSTALLATIONS

High-quality protection of installations and devices in industry is ensured by wide selection of fuse-links and circuit breakers. Particularly important is the wide range of NV/NH fuse-links and switchgear combinations, i.e. fuse blocks and switch disconnectors. We also offer MCB's and power circuit breakers ETIBREAK. And not to forget ETICON contactors, plug-in outfit and line-up terminals SPOJ and overvoltage protection devices ETITEC. As well we can not provide solutions without switch disconnectors ETISWITCH and actuators and indicators ETISIG. The products are internationally certified and carry several quality marks.

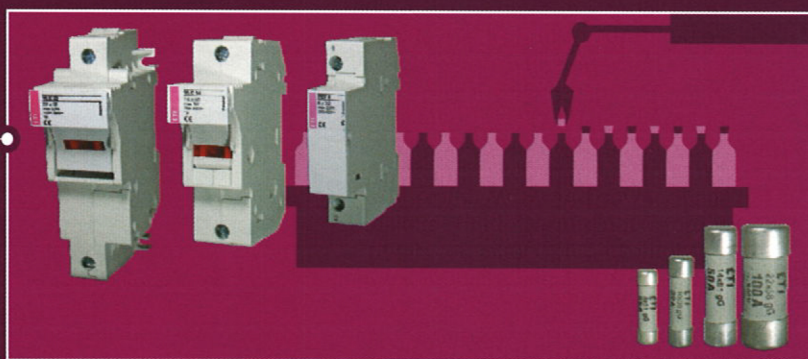

INDUSTRY

NV/NH disconnectors with fuses

NV/NH horizontal fuse-switch disconnectors KVL

Uniform cover cutout
 KVL - horizontal fuse-switch disconnectors with different sizes can be combined together and form uniform cover cutout. The new assortment contains four cover support levels at 32, 60, 70 and 90 mm above the upper of busbar. KVL fuse-switch disconnectors can be mounted on baseplates and DIN rails (for busbars see chapter ETIBUSBAR).

- Available with 1-, 2-, 3-, 4- pole versions
- Four sizes: size 00, size 1, size 2, size 3
- Use with NV/NH Fuse-links 000, 00, 1, 2, 3

Baseplate and DIN-rail mounting
 KVL disconnectors have multiple mounting holes for variability of installations. KVL-00 and KVL-1 can also be mounted on two parallel DIN-rails.



<p>KVL size 00 Ie = 160A Overall width: 106mm System size: 195mm</p>	<p>KVL size 1 Ie = 250A Overall width: 184mm System size: 300mm</p>	<p>KVL size 2 Ie = 400A Overall width: 210mm System size: 300mm</p>	<p>KVL size 3 Ie = 630A Overall width: 250mm System size: 300mm</p>
---	--	--	--

Practical advantages



Easy voltage measurements
 - Easy access with standard voltage Testers.
 Window in the handle is movable.
 - Protection degree IP2XC in normal operating condition



Safety lock
 - Prevents unauthorized operation
 - Can be used for all sizes

Simple and practical parking position
 - Safe parking position of the handle
 - Accidental reclosing not possible



Montage on DIN rails
 - Time saving installation
 - KVL-00 and KVL-1 can fit on the same TH rails

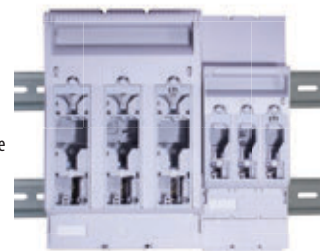

NV/NH

New generation!

Advantages

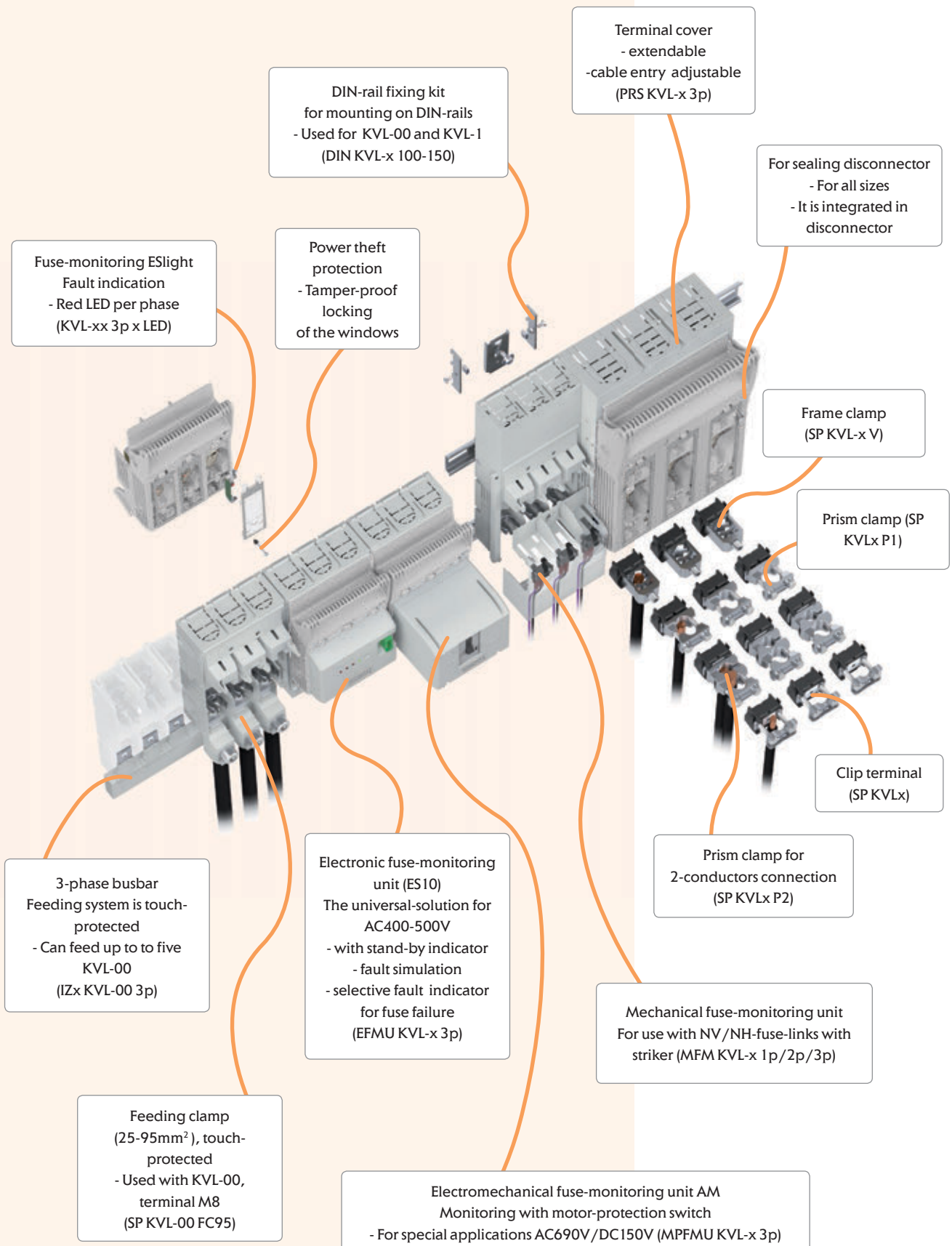

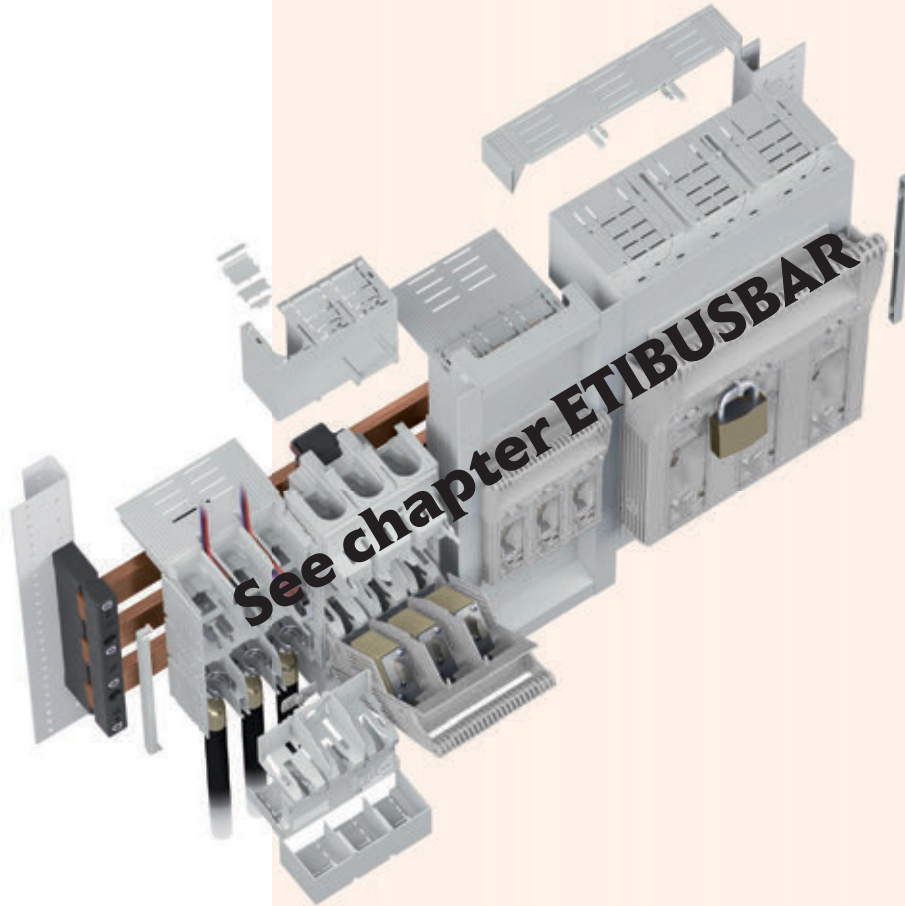

Derating factor: to operate the fuse switch disconnector in horizontal mounted position
 The fuse switch disconnectors are designed to operate in both horizontal as well as vertical mounted positions. However the main field of application is for vertical mounting because the heat dissipation on this type of mounting is considerably low. To operate them on horizontal mounted position a derating factor has to be taken in to consideration.

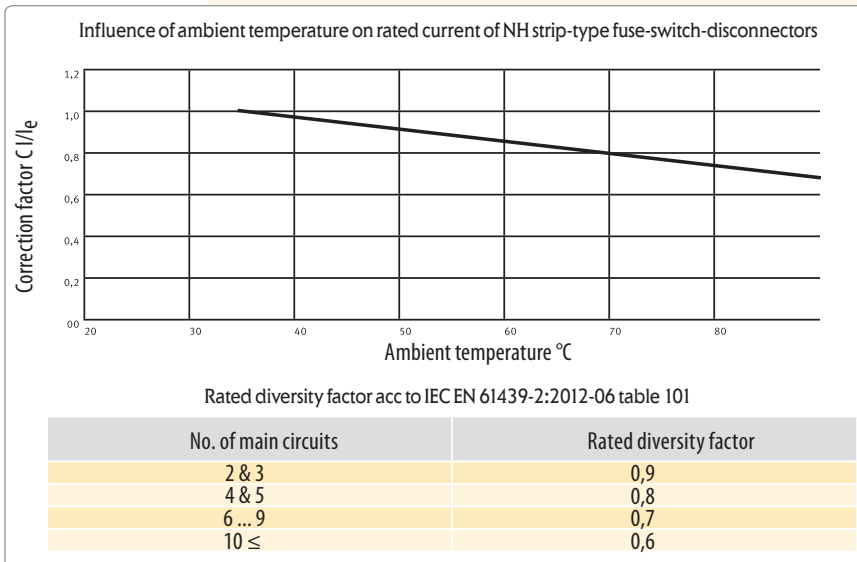
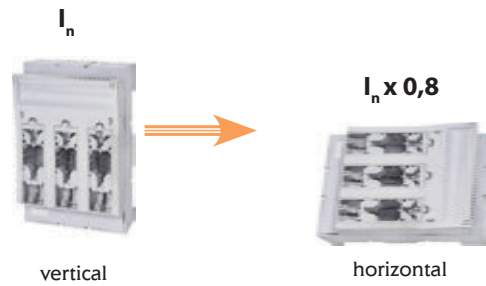

3-pole, Baseplate mounting

Size	Code No.	Type	Weight [kg]	Packaging [pcs]
00	001690870	KVL-00 3p M8-M8	0,63	1
	001690871	KVL-00 3p BC95-BC95	0,67	1
1	001690872	KVL-1 3p M10-M10	2,03	1
2	001690873	KVL-2 3p M10-M10	3,42	1
3	001690874	KVL-3 3p M10-M10	3,95	1
4a	001692620	HVL4a 3P M16 1250	15,7	1
4a	001692630	HVL4a 3P 2xM12 1600	15,7	1

3-pole, Baseplate mounting, LED indication

Size	Code No.	Type	Weight [kg]	Packaging [pcs]
00	001690880	KVL-00 3p M8-M8 LED	0,66	1
	001690881	KVL-00 3p BC95-BC95 LED	0,7	1
1	001690882	KVL-1 3p M10-M10 LED	2,06	1
2	001690883	KVL-2 3p M10-M10 LED	3,45	1
3	001690884	KVL-3 3p M10-M10 LED	3,92	1

! Only used for 400 V AC

! Not used for DC

1-pole, Baseplate mounting

Size	Code No.	Type	Weight [kg]	Packaging [pcs]
00	001690890	KVL-00 1p M8-M8	0,31	2
1	001690891	KVL-1 1p M10-M10	0,93	1
2-3	001690892	KVL-3 1p M10-M10	1,57	1
4a	001692498	HVL4a 1P M16 1250A	5,3	1
4a	001692499	HVL4a 1P 2xM12 1600A	5,3	1

2-pole, Baseplate mounting

Size	Code No.	Type	Weight [kg]	Packaging [pcs]
00	001690895	KVL-00 2p M8-M8	0,72	1
1	001690896	KVL-1 2p M10-M10	1,88	1
2-3	001690897	KVL-3 2p M10-M10	3,19	1

4-pole, Baseplate mounting

Size	Code No.	Type	Weight [kg]	Packaging [pcs]
00	001690900	KVL-00 4p M8-M8	1,19	1
1	001690901	KVL-1 4p M10-M10	2,91	1
2-3	001690902	KVL-3 4p M10-M10	5,76	1



BC95-BC95



Horizontal fuse-switch disconnecter type KVL size 00, 1, 2, 3 (baseplate mounting)

Technical data (in accordance with IEC/EN 60947-3)

Size	00						1					
Technical Characteristics												
Rated operational voltage	U_e	V	400 AC	500 AC	690 AC	250 DC	440 DC	400 AC	500 AC	690 AC	250 DC	440 DC
Rated operational current*	I_e	A	160	160	160	160	160	250	250	250	250	250
Conv. free air thermal current with fuse-links*	I_{th}	A	160					250				
Conv. free air thermal current with solid-links*	I_{th}	A	210					325				
Rated frequency	f	Hz	40-60	40-60	40-60	/	/	40-60	40-60	40-60	/	/
Rated insulation voltage	U_i	V	1000 AC					1000 AC				
Total power loss (without fuse)	P_v	W	1P - 3W, 3P - 9W					1P - 5W, 3P - 15W				
Power loss at 80% I _{th} (without fuse-links), **	P_v	W	1P - 1,9 W, 3P - 5,8 W					1P - 3,2 W, 3P - 9,6 W				
Rated impulse withstand voltage	U_{imp}	kV	8					8				
Utilisation category***			AC-23B	AC-22B	AC-21B	DC-22B	DC-21B	AC-23B	AC-22B	AC-21B	DC-22B	DC-21B
Rated conditional short-circuit current, ***, ****		kA	120 (500V), 100 (690V)					120 (500V), 100 (690V)				
Rated short-time withstand current	I_{cw}	kA	5/1s					8,6/1s				
Fuse links												
Size - DIN VDE 0636-2	-	-	000/00					1				
Max. rated current (gG)	I_n	A	160	160	160	160	160	250	250	250	250	250
Max. permissible power loss per fuse link	P_a	W	12					23				
Cable terminal												
Flat terminal-Screw			M8					M10				
Tightening torque	Ma	Nm	12-15					30-35				
Clip terminal, Clamping cross-section		mm ²	Round conductor: 1,5-70 Cu , Laminated copper bar: 6 x 9 x 0,8 Cu					Round conductor: 2,5-150 Cu , Laminated copper bar: 6 x 16 x 0,8 Cu				
Tightening torque	Ma	Nm	2,6					9,5				
Prism Clamp, Clamping cross-section		mm ²	(SP KVL00 P1); 10-70 Al/Cu , 35-95 Al/Cu					(SP KVL1 P1); 10-150 Al/Cu				
Tightening torque	Ma	Nm	(SP KVL00 P1); 2,6					(SP KVL1 P1); 4,5				
Prism Clamp, Clamping cross-section		mm ²						(SP KVL1 P2); 2 x (10-150) Al/Cu				
Tightening torque	Ma	Nm						(SP KVL1 P2); 4,5				
Frame clamp, Clamping cross-section		mm ²	1,5-95 Al/Cu , (Al 95: max. 125A), *****					35-150 Al/Cu				
Torque	Ma	Nm	4,5					12				
Degree of Protection, front side device												
Front cover close	-	-	IP20					IP20				
Front cover open	-	-	IP10					IP10				
With clamp- and lateral cover	-	-	IP2XC					IP2XC				
Operating condition												
Ambient temperature *****	T_{amb}	°C	-25 ... +55					-25 ... +55				
Operating condition	-	-						Continuous operation				
Mounting	-	-						vertical, horizontal				
Altitude	-	m						≤ 2000				
Pollution degree	-	-						3				
Overvoltage category	-	-	III					III				

* Mounting of several units in low voltage switchgear-combinations, please think about rated diversity factors acc. to DIN EN 61439.

** Reference value for replacement of devices acc. to DIN EN 61439-1 clause 10.10.4.2.

*** minimum distance to earthed, conductive parts: Lateral: 20mm/Above: 50mm

*** a) Lateral: 50mm/Above: 100mm

**** Type tested with NH fuse-links characteristic gG

***** 35°C Normal temperature, at 55°C with reduced operating current

Technical data

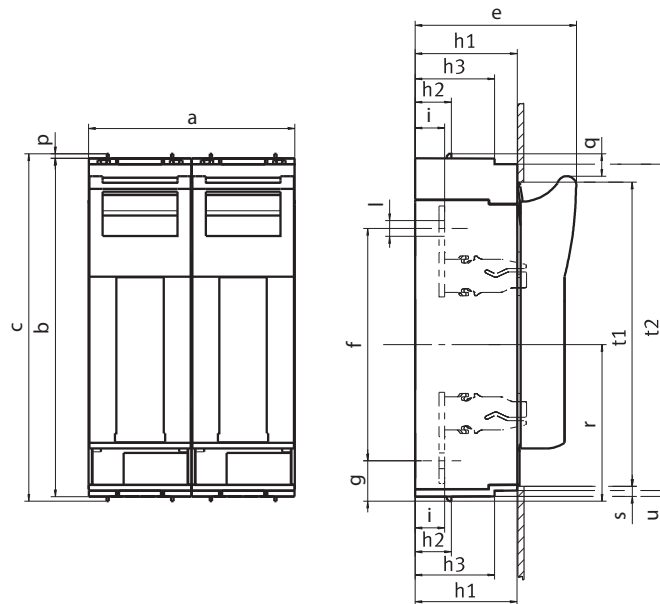

	a	b	c	e	f	g	h1	h2	h3	i	l	p	q	r	s	t1	t2	u
KVL-1 2p M10-M10	138	298	306	117	185	46	70	32	-	25	∅10,5	4	19	138	5	272	-	-
KVL-3 2p M10-M10	182	298	306	143	205	36	90	32	70	26	∅14	4	19	138	10	268	288	5

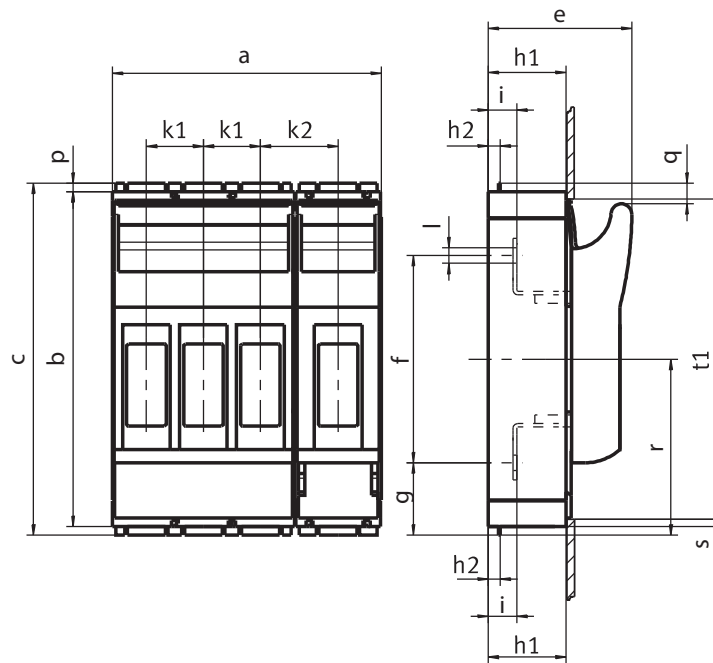

	a	b	c	e	f	g	h1	h2	h3	k1	k2	i	l	p	q	r	s	t1	t2	u
KVL-00 4p M8-M8	156	195	204	84	120	42	45	7	-	33	45	16,5	∅9	4,5	12	102	5	187	-	-